

Model No.4327 JIG SAW

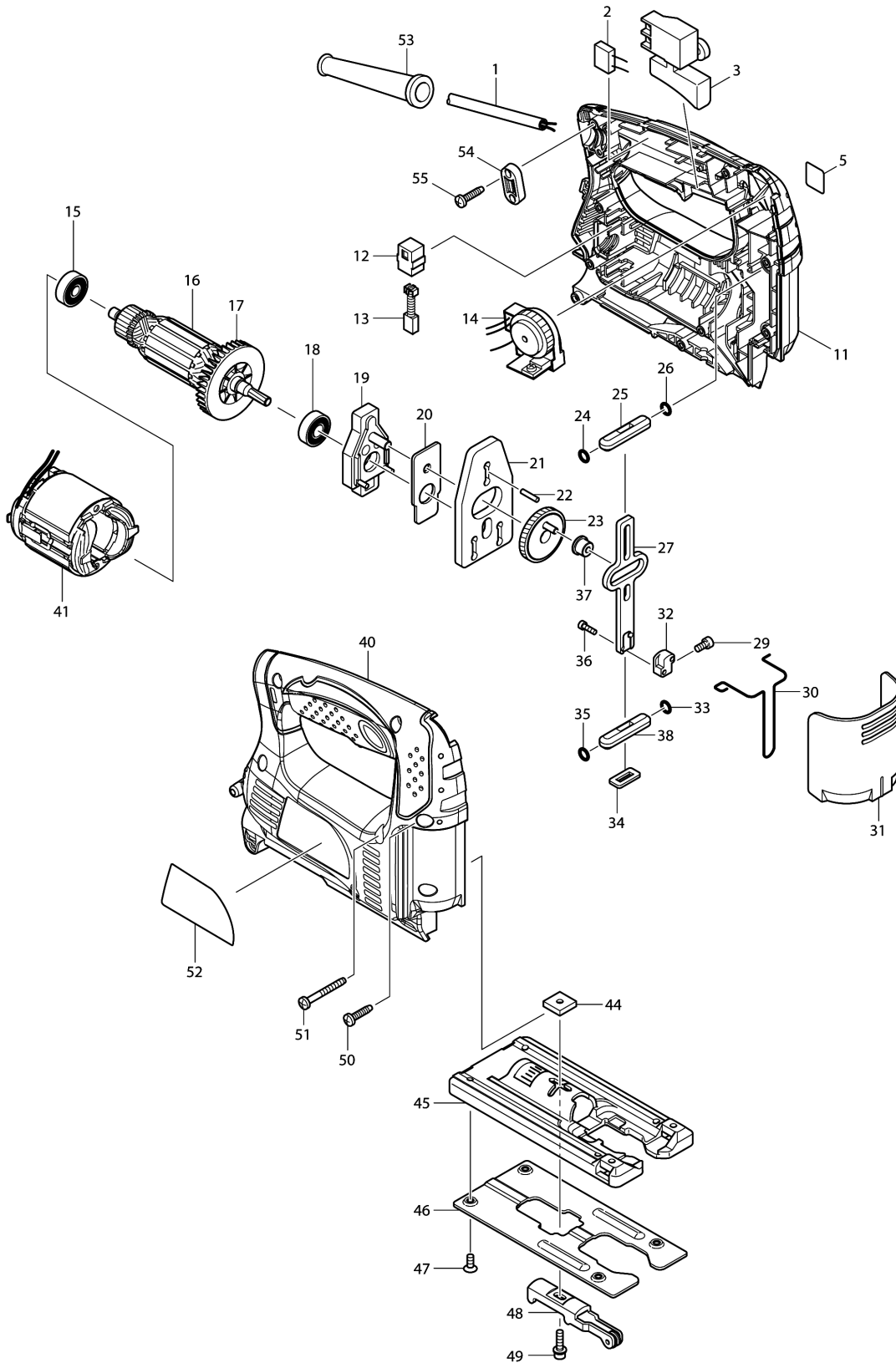

Model No.4327 JIG SAW

Item	Parts No.	Description	I/C	Qty	New/Old	Opt. 1	Opt. 2	Note
001	665383-1	POWER SUPPLY CORD 1.0-2-2.0		1				
002	645239-4	NOISE SUPPRESSOR		1				
003	651286-5	SWITCH SGEL206C-5		1				
011	188342-3	HOUSING SET		1				
C10	263002-9	RUBBER PIN 4		2				
D10		INC. 40						
012	643562-1	BRUSH HOLDER 5X8		2	*			
012-1	643552-4	BRUSH HOLDER 5-8	O	2				
013	191627-8	CARBON BRUSH CB-64		1				
014	631777-2	CONTROLLER		1	*			
014-1	620411-9	CONTROLLER	O	1				
015	210025-8	BALL BEARING 627LLB		1				
016	515718-5	ARMATURE ASS'Y 220V		1				
D10		INC. 15,17,18						
017	241881-5	FAN 52		1				
018	210005-4	BALL BEARING 608DDW		1				
019	152577-2	BEARING CASE COMPLETE		1				
020	344615-6	THRUST PLATE		1				
021	344614-8	BALANCE PLATE		1				
022	256254-9	PIN 3		1				
023	153254-9	GEAR COMPLETE		1				
024	213038-8	O RING 5		1				
025	313082-6	SLIDER GUIDE		1				
026	213038-8	O RING 5		1				
027	344613-0	SLIDER		1				
029	922107-1	HEX. SOCKET HEAD BOLT M4X8		1				
030	323748-0	SAFETY WIRE		1				
031	416476-5	DUST COVER		1				
032	313140-8	BLADE CLAMP		1				
033	213038-8	O RING 5		1				
034	423307-1	POLY URETANE SPONGE SEAL		1				
035	213038-8	O RING 5		1				
036	266177-3	HEX. SOCKET HEAD BOLT M3X10		2				
037	257683-9	COLLAR SLEEVE		1				
038	313082-6	SLIDER GUIDE		1				
040	188342-3	HOUSING SET		1				
C10	263002-9	RUBBER PIN 4		2				
D10		INC. 11						
041	633658-6	FIELD 220-240V		1				
044	343540-8	HOLDER		1				

Model No.4327 JIG SAW

Item	Parts No.	Description	I/C	Qty	New/Old	Opt. 1	Opt. 2	Note
045	163397-9	BASE		1				
048	158393-0	RETAINER COMPLETE		1				
049	922128-3	HEX. SOCKET HEAD BOLT M4X16		1				
050	265995-6	TAPPING SCREW 4X18		9				
051	266053-1	TAPPING SCREW 4X35		1				
052	863950-8	4327 NAME PLATE		1				
053	682569-2	CORD GUARD 8-85		1	*			
053-1	682502-4	CORD GUARD 8-85	O	1				
054	687124-5	STRAIN RELIEF		1	*			
054-1	687052-4	STRAIN RELIEF	O	1	*			
054-2	687124-5	STRAIN RELIEF	O	1				
055	265995-6	TAPPING SCREW 4X18		2				
A01	792538-6	JIG SAW BLADE B-10		1	*			
A01-1	A-85628	JIGSAW BLADE NO.B10	<	1				
A02	783201-2	HEX. WRENCH 3		1				
E03	688165-4	LINE FILTER		1				

Please order the parts with part number.

Print Date 8/9/2020