

# Model No.4328 JIG SAW

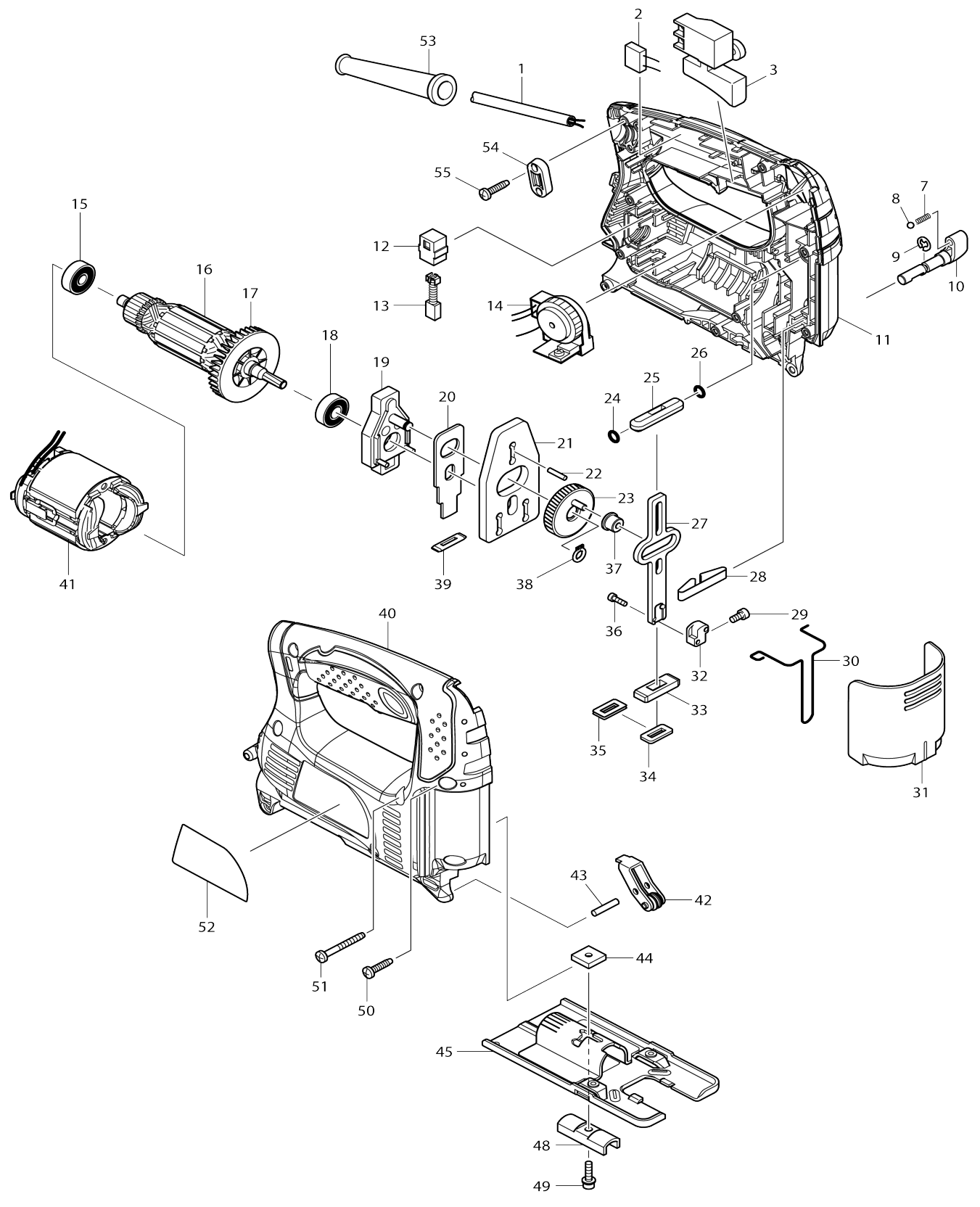

Model No.4328 JIG SAW

Item No.	Parts No.	Description	Interchangability	Q'ty	New/Old	Note1	Note2
001	665383-1	POWER SUPPLY CORD 1.0-2-2.0		1			
002	645239-4	NOISE SUPPRESSOR		1			
003	651286-5	SWITCH SGEL206C-5		1	*		
003-1	651286-5	SWITCH SGEL206C-5	O	1			
007	233151-6	COMPRESSION SPRING 4		1			
008	216008-6	STEEL BALL 4		1			
009	961011-9	STOP RING E-4		1			
010	272239-7	LEVER 18		1			
011	188338-4	HOUSING SET		1			
C10	263002-9	RUBBER PIN 4		2			
D10		INC. 40					
012-1	643552-4	BRUSH HOLDER 5-8		2			
013	191627-8	CARBON BRUSH CB-64		1	*		
013-1	194968-1	CARBON BRUSH SET CB-64	O	1			
014	631777-2	CONTROLLER		1	*		
014-1	620411-9	CONTROLLER	O	1			
015	210025-8	BALL BEARING 627LLB		1			
016	515718-5	ARMATURE ASS'Y 220V		1			
D10		INC. 15,17,18					
017	241881-5	FAN 52		1			
018	210005-4	BALL BEARING 608DDW		1			
019	152600-3	BEARING CASE COMPLETE		1			
020	344683-9	PUSH PLATE		1			
021	344614-8	BALANCE PLATE		1			
022	256254-9	PIN 3		1			
023	153260-4	GEAR COMPLETE		1			
024	213038-8	O RING 5		1			
025	313082-6	SLIDER GUIDE		1			
026	213038-8	O RING 5		1			
027	344613-0	SLIDER		1			
028	232183-0	LEAF SPRING		1			
029	922107-1	HEX. SOCKET HEAD BOLT M4X8		1			
030	323748-0	SAFETY WIRE		1			
031	416476-5	DUST COVER		1			
032	313140-8	BLADE CLAMP		1			
033	313086-8	SLIDER SUPPORT		1			
034	423307-1	POLYURETHANE SPONGE SEAL		1			
035	344686-3	SEAL PLATE		1			
036	266177-3	HEX. SOCKET HEAD BOLT M3X10		2			
037	257683-9	COLLAR SLEEVE		1			
038	961002-0	RETAINING RING S-6		1			
039	416703-0	DUST SEAL		1			
040	188338-4	HOUSING SET		1			
C10	263002-9	RUBBER PIN 4		2			
D10		INC. 11					
041	633658-6	FIELD 220-240V		1			
042	158392-2	RETAINER COMPLETE		1			

043	256117-9	PIN 4		1		
044	343540-8	HOLDER		1		
045	163397-9	BASE		1		
048	344685-5	CLAMP PLATE		1	*	
048-1	344685-5	CLAMP PLATE	O	1		
049	922128-3	HEX. SOCKET HEAD BOLT M4X16		1		
050	265995-6	TAPPING SCREW 4X18		9		
051	266053-1	TAPPING SCREW 4X35		1		
052	863965-5	4328 NAME PLATE		1		
053-1	682502-4	CORD GUARD 8-85		1		
054-1	687052-4	STRAIN RELIEF		1	*	
054-2	687124-5	STRAIN RELIEF	O	1		
055	265995-6	TAPPING SCREW 4X18		2		
A01-1	A-85628	JIGSAW BLADE NO.B10		1		
A02	783201-2	HEX. WRENCH 3		1		
E03	688165-4	LINE FILTER		1		

Please state Parts No. when your order.

Print Date 12/04/2023