

Model No.9911 BELT SANDER 76MM

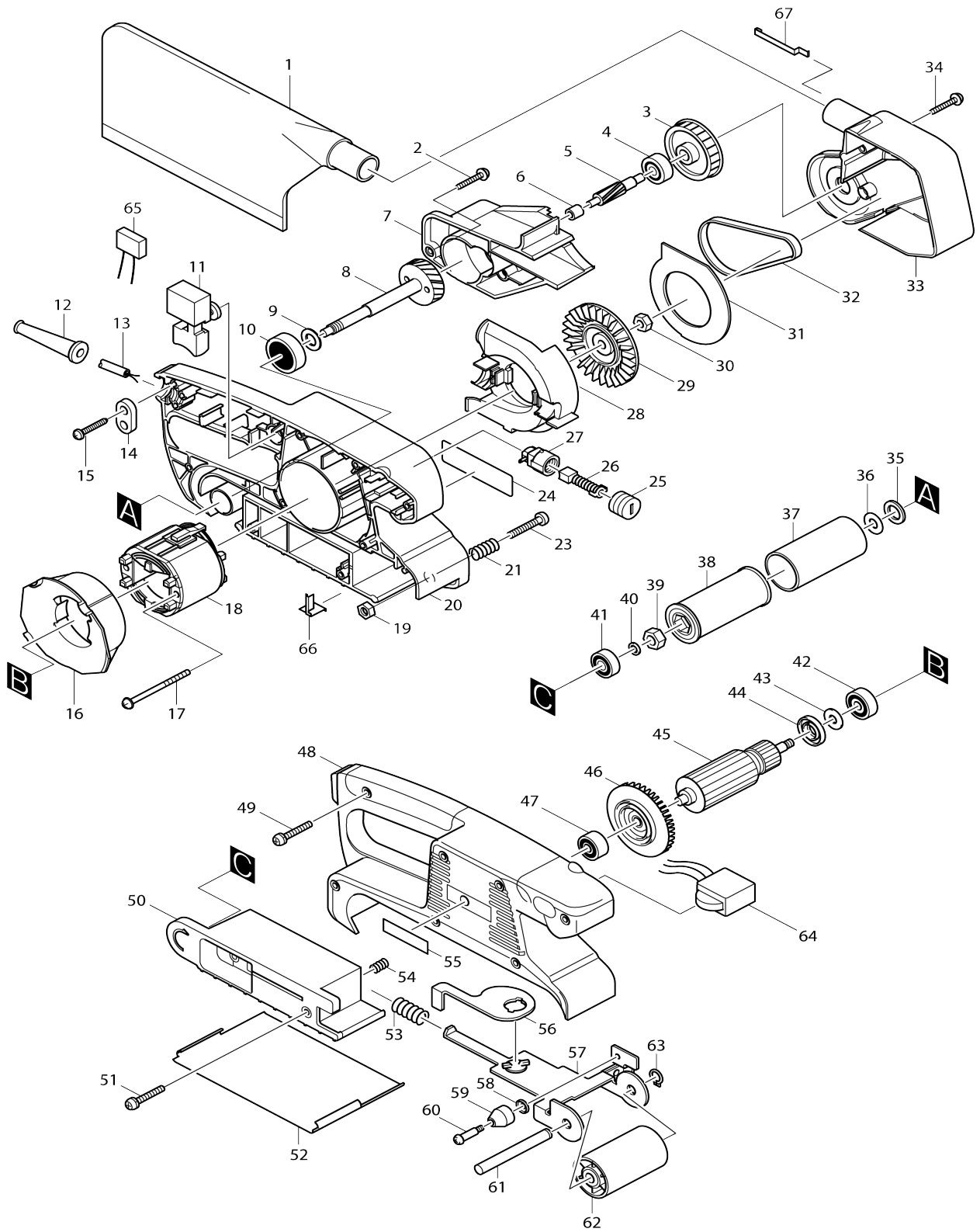

Model No.9911 BELT SANDER 76MM

Item No.	Parts No.	Description	Interchangability	Q'ty	New/Old	Note1	Note2
001	122548-3	DUST BAG ASS'Y		1			
C10	410602-8	FASTENER		1			
002A_	266119-7	TAPPING SCREW FLANGE PF 4X25		4	*		
002A1	265999-8	TAPPING SCREW 4X25	O	4			
003	222144-8	PULLEY 8.5-45.1		1			
004	210005-4	BALL BEARING 608DDW		1			
005	226494-3	HELICAL GEAR 6		1			
006	212009-2	NEEDLE BEARING 509		1			
007	416420-2	BRACKET		1			
008	153252-3	HELICAL GEAR 31 COMPLETE		1			
009	253758-2	FLAT WASHER 10		1			
010	211061-7	BALL BEARING 6000LLB		1			
011	651285-7	SWITCH SGEL206C-4		1	*		
011-1	650232-5	SWITCH TGL215CDT-1	O	1			
012A_	682502-4	CORD GUARD 8-85		1			
013E_	665394-6	POWER SUPPLY CORD 1.0-2-2.5		1			
014B_	687052-4	STRAIN RELIEF		1			
015A_	266121-0	TAPPING SCREW FLANGE PF 4X18		2	*		
015A1	265995-6	TAPPING SCREW 4X18	O	2			
016	416418-9	BAFFLE PLATE		1			
017A_	266114-7	TAPPING SCREW FLANGE PF 4X60		2	*		
017A1	266052-3	TAPPING SCREW 4X60	O	2			
018B_	633393-6	FIELD 220-240V		1			
019	931202-6	HEX. NUT M5		1			
020	150958-4	HOUSING L COMPLETE		1			
D10		INC. 6,19					
021	233219-8	COMPRESSION SPRING 6		1			
023	911252-7	PAN HEAD SCREW M5X30		1			
024	859230-8	NAME PLATE 9911		1	*		
024-1	859603-5	NAME PLATE 9911	<	1			
025	643550-8	BRUSH HOLDER CAP 5-8		2			
026A_	191940-4	CARBON BRUSH CB-411		1	*		
026A1	195010-1	CARBON BRUSH SET CB-411	O	1			
027	643922-7	BRUSH HOLDER		2			
028	416416-3	SCROLL PLATE		1			
029	241660-1	FAN 68		1			
030	252153-3	HEX. NUT M6-10		1			
031	344584-1	PLATE		1			
032	225079-2	SYNCHRO BELT 6-300		1			
033	416415-5	BELT COVER		1	*		
033-1	183021-8	BELT COVER SET	X	1			
D10		INC. 67					
034A_	266119-7	TAPPING SCREW FLANGE PF 4X25		4	*		
034A1	265999-8	TAPPING SCREW 4X25	O	4			
035	267177-6	FLAT WASHER 12		1			

036	253865-1	FLAT WASHER 8		1		
037	422032-1	RUBBER SLEEVE 29		1		
038	316971-4	DRIVING ROLLER		1		
039	252154-1	HEX. NUT M8-13		1		
040	253077-6	FLAT WASHER 6		1		
041	210022-4	BALL BEARING 626DDW		1		
042	210023-2	BALL BEARING 627DDW		1		
043	253823-7	FLAT WASHER 7		1		
044	681648-3	INSULATION WASHER		1	*	
044-1	681658-0	INSULATION WASHER	X	1		
045B_	517243-2	ARMATURE ASS'Y 220-240V		1		
D10		INC. 42-44,46,47				
046	240008-4	FAN 60		1		
047	211021-9	BALL BEARING 607LLB		1		
048	182982-9	HOUSING R		1		
D10		INC. 55				
049A_	266119-7	TAPPING SCREW FLANGE PF 4X2 5		7	*	
049A1	265999-8	TAPPING SCREW 4X25	O	7		
050	416419-7	SHOE		1		
051A_	266119-7	TAPPING SCREW FLANGE PF 4X2 5		2	*	
051A1	265999-8	TAPPING SCREW 4X25	O	2		
052	344586-7	STEEL PLATE		1	*	
052-1	345503-0	STEEL PLATE	O	1	*	
052-2	344586-7	STEEL PLATE	O	1		
053	233221-1	COMPRESSION SPRING 12		1		
054-1	231038-6	COMPRESSION SPRING 6		1		
055	819063-3	MAKITA LABEL		1		
056	344585-9	LEVER		1		
057	150837-6	TENSION ROLLER ARM COMPLETE		1		
058	267731-6	CUP WASHER 4		1		
059	416417-1	ROLLER		1		
060	265059-6	SHOULDER SCREW M4		1		
061	323776-5	TENSION ROLLER SHAFT		1		
062	152585-3	TENSION ROLLER COMPLETE		1		
063	961004-6	RETAINING RING (EXT) S-8		1		
064A_	631202-3	CONTROLLER 200-240V		1	*	
064A1	631678-4	CONTROLLER	O	1		
066	344703-9	EARTH SUPPORTER		1		
067	344701-3	EARTH PLATE		1		
068	632800-6	LEAD UNIT		2		
A01	794551-0	ABRASIVE BELT 76X457 WA80		1	*	
A01-1	D-59209	ABRASIVE BELT 76X457 #80	X	1		
E02B_	645200-1	NOISE SUPPRESSOR		1	*	
E02B1	645146-1	NOISE SUPPRESSOR	O	1		
E03	652259-1	CLAMP WASHER		4	*	
F03	192694-6	CLAMP COMPLETE		0		
A01	193957-3	ABRASIVE BELT SET		1		
A02	824733-1	PLASTIC CARRYING CASE		1	*	
A02-1	824982-0	PLASTIC CARRYING CASE	S	1		

C10	162271-8	LATCH		2		
C20	450990-1	HANDLE		1		
A03	824732-3	INNER TRAY		1	*	
A03-1	837721-9	INNER TRAY	S	1		
A04	794551-0	ABRASIVE BELT 76X457 WA80		1	*	
A04-1	D-59209	ABRASIVE BELT 76X457 #80	X	1		
013D 1	665394-6	POWER SUPPLY CORD 1.0-2-2.5		1		
014A1	687052-4	STRAIN RELIEF		1		
A02	821551-8	CONNECTOR PLASTIC CASE (TYP E3)		1		
C10	453974-8	LATCH		4		
A03	837658-0	INNER TRAY		1		
A04	800X32-9	9911J INDICATION LABEL		1		
A05	800X33-7	9911J PLASTIC CASE LABEL		2		
A06	794551-0	ABRASIVE BELT 76X457 WA80		1	*	
A06-1	D-59209	ABRASIVE BELT 76X457 #80	X	1		

Please state Parts No. when your order.

Print Date 27/12/2023