

Model No.ADP05 ADAPTER FOR USB

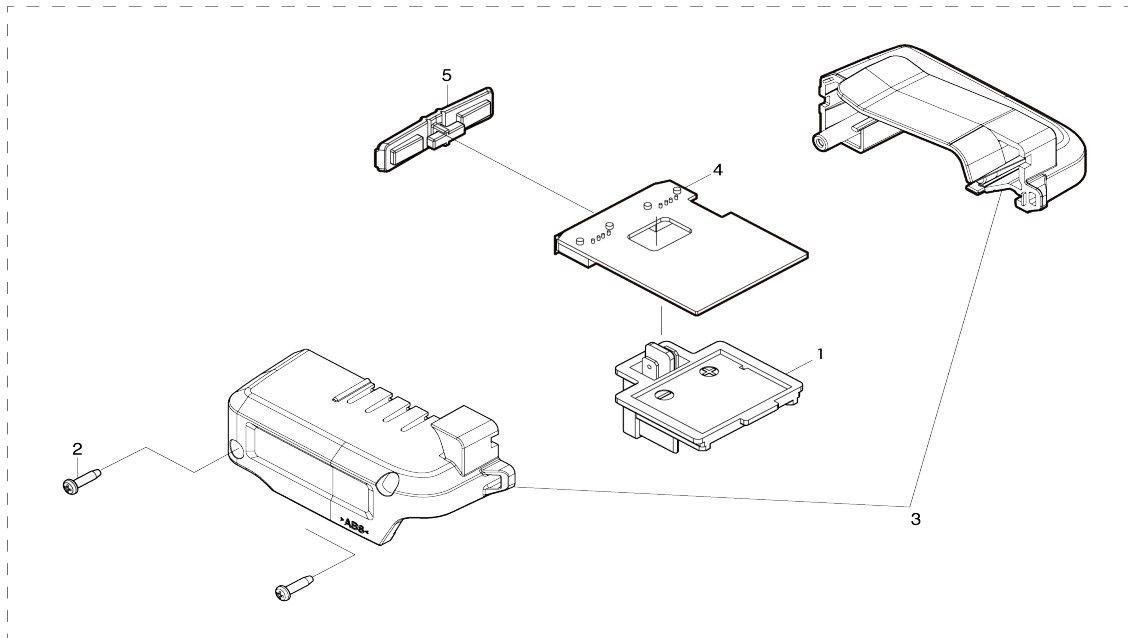
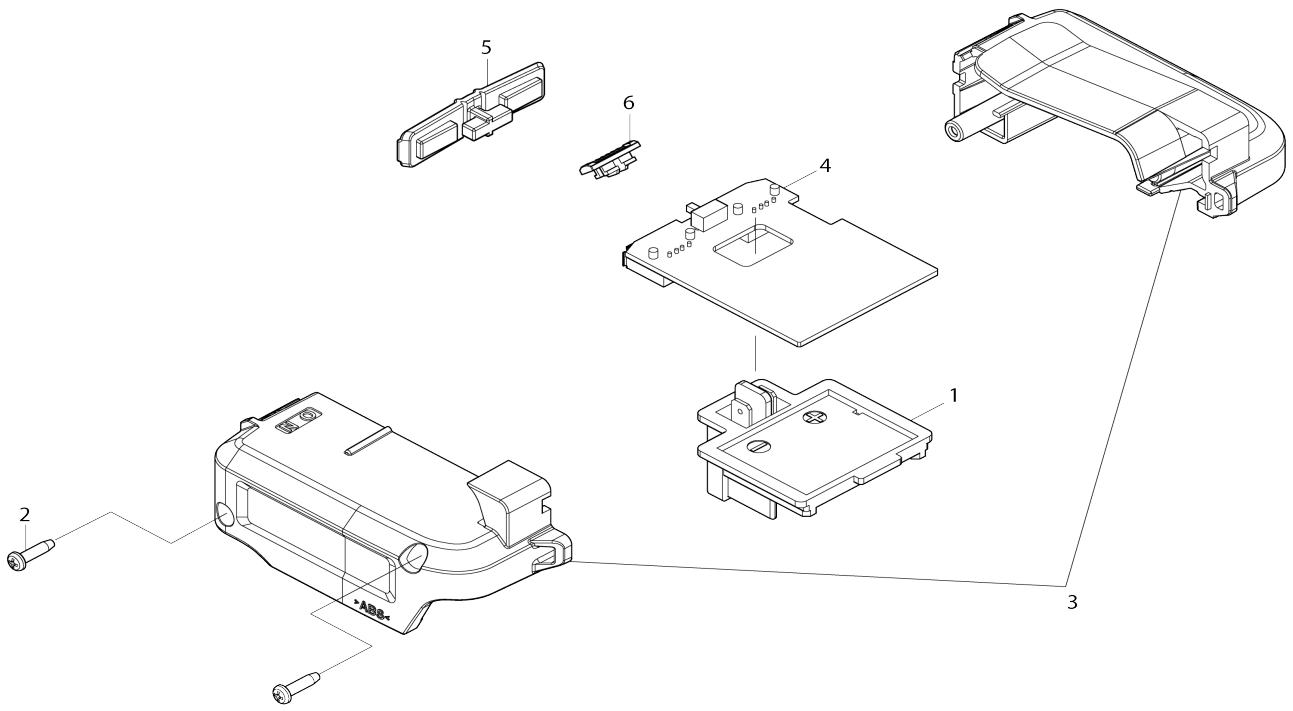

Model No.ADP05 ADAPTER FOR USB

Item No.	Parts No.	Description	Interchangability	Q'ty	New/Old	Note1	Note2
001	SE00000261	TERMINAL 2100PC01300		1			
002	SE00000451	SCREW PTB 3X12 ZK 29S16312001		2			
003	SE00000452	CASE L/R SET 011ABA1		1	*		
003-1	SE00000493	CASE L/R SET	S	1			
004	SE00000454	PCB A ASSY 07AAB01		1	*		
004-1	SE00000492	PCB A ASS'Y	S	1			
005	SE00000453	USB COVER 3120AB0000010		1			
006	SE00000495	SLIDE KNOB	S	1			
F06	199010-3	USB CABLE SET(EU)		1	*		
F06-1	199006-4	USB CABLE SET	O	1			
F09	199178-5	USB CABLE SET		1			
003	SE00000493	CASE L/R SET		1			
004	SE00000492	PCB A ASS'Y		1			

Please state Parts No. when your order.

Print Date 10/10/2023