

Model No.AF506 PNEUMATIC BRAD NAILER

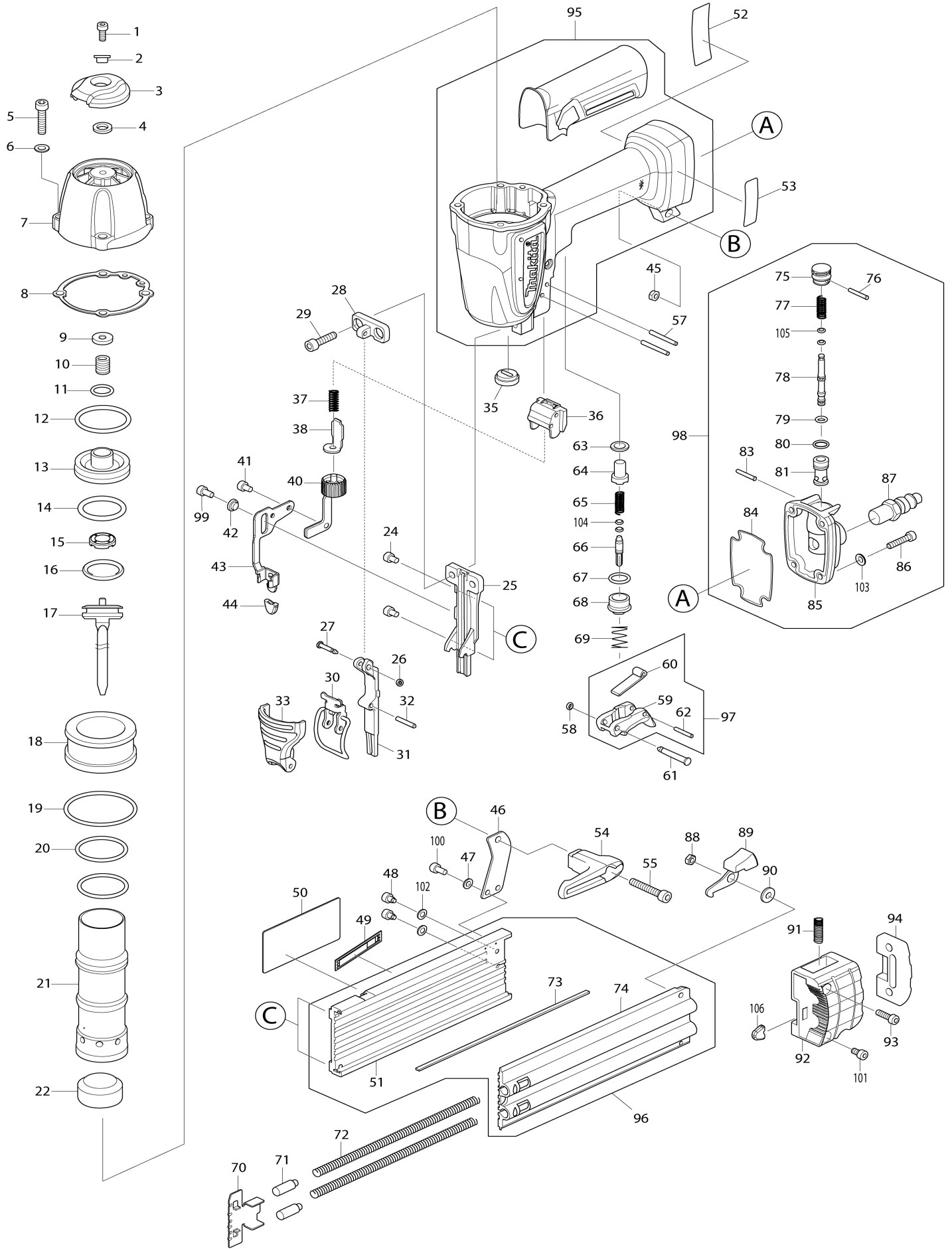

Model No.AF506 PNEUMATIC BRAD NAILER

Item No.	Parts No.	Description	Interchangability	Q'ty	New/Old	Note1	Note2
001	HY00000001	HEX.SOCKET HEAD BOLT M4X10		1			
002	HY00000002	SLEEVE4		1			
003	HY00000508	EXHAUSTCOVER		1			
004	HY00000004	RUBBER WASHER 7		1			
005	HY00000049	HEX.SOCKET HEAD BOLT M5X22		4			
006	HY00000160	FLAT WASHER 5		4			
007	HY00000511	TOPCAP		1			
008	HY00000509	TOPCAPGASCKET		1			
009	HY00000008	CUSHION V		1			
010	HY00000629	COMPRESSIONSPRING7		1			
011	HY00000010	O-RING 12		1			
012	HY00000011	O-RING 33		1			
013	HY00000507	HEADVALVE		1			
014	HY00000408	ORING26.5		1			
015	HY00000014	CUSHION P		1			
016	HY00000400	ORING22.5		1			
017	HY00000911	DRIVER COMPLETE		1			
018	HY00000912	CYLINDER SEPARATER		1			
019	HY00000016	O-RING 46		1			
020	HY00000409	ORING30.5		2			
021	HY00000913	CYLINDER		1			
022	HY00000546	FRONTCUSHION		1			
024	HY00000074	HEX.SOCKET HEAD BOLT M4X8		2			
025	HY00000914	DRIVER GUIDE		1			
026	HY00000043	RUBBER RING 2		1			
027	HY00000915	COVER PLATE PIN		1			
028	HY00000916	PLATE		1			
029	HY00000005	HEX.SOCKET HEAD BOLT M5X20		2			
030	HY00000917	LATCH		1			
031	HY00000918	DOOR		1			
032	HY00000531	SPRINGPIN3-22		1			
033	HY00000919	LATCH COVER		1			
035	HY00000023	FRONT SEAL		1			
036	HY00000506	HOLDER		1			
037	HY00000421	COMPRESSIONSPRING5		1			
038	HY00000444	UPPERYOKE		1			
040	HY00000950	CONTACT ARM COMPLETE		1			
041	HY00000649	HEX.SOCKETHEADBOLTM4X4		1			
042	HY00000633	BUSH		1			
043	HY00000923	CONTACT TOP		1			
044	HY00000378	NOSE ADAPTER (2PCS)		1			
D10		INC. 106					
045	HY00000924	HEX. LOCK NUT M5		1			
046	HY00000925	JOINT		1			
047	HY00000070	FLAT WASHER4		1			
048	HY00000926	HEX. SOCKET HEAD BOLT M4X6		2			
049	HY00000927	SENSORMATIC CHIP		1			

050	HY00000928	CAUTION LABEL1		1		
051	HY00000929	MAGAZINE		1		
052	HY00000930	AF506 NAME PLATE		1		
053	HY00000931	CAUTION LABEL2		1		
054	HY00000062	HOOK		1		
055	HY00000156	HEX.SOCKET HEAD BOLT M5X25		1		
057	HY00000024	SPRING PIN 3-26		2		
058	HY00000037	O-RING 3		1		
059	HY00000436	TRIGGER		1		
060	HY00000932	IDLER		1		
061	HY00000933	PIN4		1		
062	HY00000114	SPRING PIN 2.5-16		1		
063	HY00000033	RUBBER RING 8		1		
064	HY00000034	TRIGGER VALVE GUIDE		1		
065	HY00000035	COMPRESSION SPRING 4		1		
066	HY00000934	TRIGGER VALVE STEM		1		
067	HY00000039	O-RING 11		1		
068	HY00000038	TRIGGER VALVE CASE		1		
069	HY00000040	COMPRESSION SPRING 10		1		
070	HY00000935	PUSHER		1		
071	HY00000936	PIN7		2		
072	HY00000059	COMPRESSION SPRING 6		2		
073	HY00000937	MAGAZINE RAIL		1		
074	HY00000938	SLIDE DOOR		1		
075	HY00000573	DUSTERBUTTON		1		
076	HY00000046	PIN 2-10		1		
077	HY00000589	COMPRESSIONSPRING5		1		
078	HY00000513	VALVESTEM		1		
079	HY00000397	ORING5		1		
080	HY00000399	ORING8.5		1		
081	HY00000599	VALVEGUIDE		1		
083	HY00000054	SPRING PIN 2.5-18		1		
084	HY00000580	SEALRING		1		
085	HY00000499	INLETCAP		1		
086	HY00000650	HEX.SOCKETHEADBOLTM4X20		4		
087	HY00000081	ONE TOUCH JOINT		1		
088	HY00000159	HEX. LOCK NUT M4		1		
089	HY00000941	LOCK LEVER		1		
090	HY00000942	SLEEVE4		1		
091	HY00000943	COMPRESSION SPRING 5		1		
092	HY00000944	SLIDE DOOR CAP		1		
093	HY00000647	HEX.SOCKETHEADBOLTM4X12		1		
094	HY00000945	CAP BUMPER		1		
095	HY00000946	HOUSING COMPLETE		1		
096	HY00000947	MAGAZINE ASSEMBLY		1		
D10		INC. 51,73,74				
097	HY00000948	TRIGGER ASSEMBLY		1		
D10		INC. 59,60,62				
098	HY00000494	AIRDUSTERCOMPLETE		1		
D10		INC. 75-81,83-87,103,105				
099	HY00000074	HEX.SOCKET HEAD BOLT M4X8		1		
100	HY00000074	HEX.SOCKET HEAD BOLT M4X8		2		

101	HY00000074	HEX.SOCKET HEAD BOLT M4X8		1			
102	HY00000070	FLAT WASHER4		2			
103	HY00000070	FLAT WASHER4		4			
104	HY00000037	O-RING 3		2			
105	HY00000037	O-RING 3		2			
106	HY00000378	NOSE ADAPTER (2PCS)		1			
D10		INC. 44					
A01	HY00000951	SAFETY GOGGLE		1			
A02-1	181434-7	OIL SUPPLY 30CC		1	*		
A02-2	HY00000952	OIL SUPPLY	O	1			
A04	HY00001107	PLASTIC CASE		1			

Please state Parts No. when your order.

Print Date 10/10/2023