

Model No. AN943 FRAMING NAILER (CLIP HEAD)

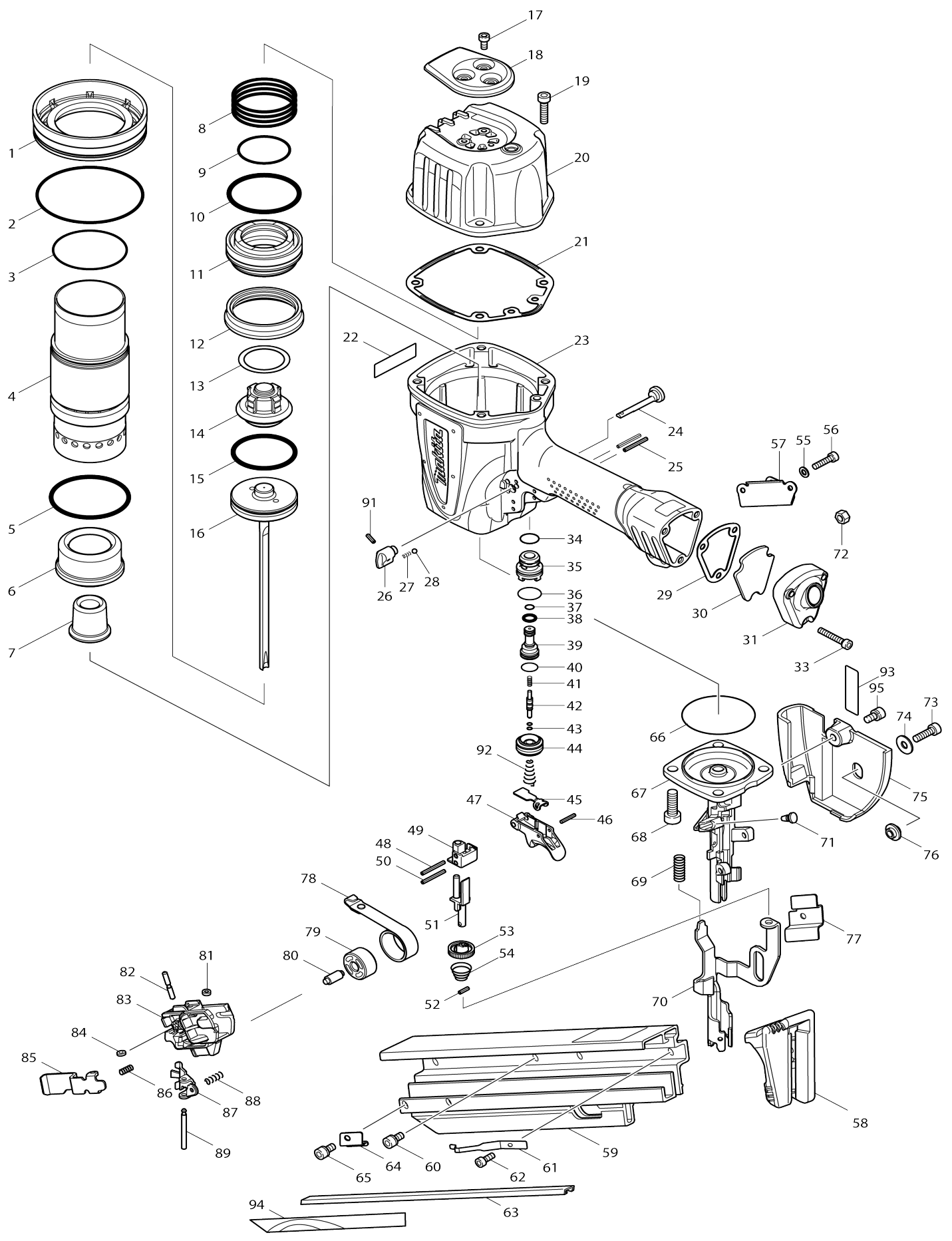

Model No.AN943 FRAMING NAILER (CLIP HEAD)

Item No.	Parts No.	Description	Interchangability	Q'ty	New/Old	Note1	Note2
001	419115-6	CYLINDER SEPARATOR		1			
002	213809-3	O RING 87		1			
003	213668-5	O RING 60		1			
004	331700-4	CYLINDER		1			
005	213667-7	O RING 60		1			
006	421680-3	CUSHION F		1			
007	421687-9	CUSHION GUIDE		1			
008	233243-1	COMPRESSION SPRING 50		1			
009	213504-5	O RING 40		1			
010	213669-3	O RING 56		1			
011	419114-8	HEAD VALVE		1			
012	421925-9	VALVE SEAT		1			
013	267742-1	WASHER 34		1			
014	421924-1	CUSHION REAR		1			
015	213619-8	O RING 49		1			
016	154652-0	DRIVER COMPLETE		1			
017	265499-8	HEX.SOCKET HEAD BOLT M5X10		3			
018	345618-3	EXHAUST COVER		1			
019	922342-1	HEX. SOCKET HEAD BOLT M6X25		4			
020	317950-5	TOP CAP		1			
021	162238-6	TOPCAP GASKET		1			
023	154820-5	HOUSING COMPLETE		1			
C10	421921-7	GRIP		1			
C20	421922-5	HOUSING BUMPER R		1			
C30	421923-3	HOUSING BUMPER L		1			
C40	817592-0	CAUTION LABEL		1			
024	324117-8	LOCK PIN 8		1			
025	951075-1	SPRING PIN 3-28		2			
026	417824-1	LEVER 8		1			
027	233368-1	COMPRESSION SPRING 3		1			
028	216008-6	STEEL BALL 4		1			
029	162239-4	INLET CAP GASKET		1			
030	419356-4	INLET FILTER		1			
031	318005-9	INLET CAP		1			
033	922252-2	HEX. SOCKET HEAD BOLT M5X30		3			
034	213176-6	O RING 14		1			
035	417695-6	TRIGGER VALVE GUIDE		1			
036	213262-3	O RING 18		1			
037	213039-6	O RING 6		1			
038	213040-1	O RING 8		1			
039	317959-7	PILOT VALVE		1			
040	213122-9	O RING 12		1			
041	233239-2	COMPRESSION SPRING 3		1			
042	324591-0	TRIGGER VALVE STEM		1			
043	213044-3	O RING 3		2			
044	318010-6	TRIGGER VALVE CASE		1			
045	345687-4	IDLER		1			

046	258004-8	SPRING PIN 2.5-16		1		
047	419418-8	TRIGGER		1		
048	951075-1	SPRING PIN 3-28		1		
049	310165-3	HOLDER		1		
050	951075-1	SPRING PIN 3-28		1		
051	310166-1	STOPPER		1		
052	951054-9	SPRING PIN 3-10		1		
053	310163-7	ADJUSTER		1		
054	231978-8	CONICAL COMP. SPRING 9-16		1		
055	267300-3	FLAT WASHER 5		2		
056	266369-4	HEX SOCKET HEAD BOLT M5X20		2		
057	345626-4	JOINT		1		
058	419117-2	MAGAZINE CAP		1		
059	154823-9	MAGAZINE COMPLETE		1		
C10	810022-0	CAUTION LABEL		1	*	
C11	816R52-7	CAUTION LABEL	<	1		
060	266370-9	HEX SOCKET HEAD BOLT M6X12		2		
061	345619-1	NAIL STOPPER		1		
062	922217-4	HEX. SOCKET HEAD BOLT M5X14		1		
063	345620-6	MAGAZINE RAIL		1		
064	344765-7	HOLDER		1		
065	266370-9	HEX SOCKET HEAD BOLT M6X12		1		
066	213654-6	O RING 60		1		
067	310164-5	DRIVER GUIDE		1		
068	266368-6	HEX SOCKET HEAD BOLT M8X25		4		
069	233463-7	COMPRESSION SPRING 10		1		
070	345622-2	CONTACT ARM		1		
071	421418-6	RUBBER PIN 9.5		1		
072	931302-2	HEX. NUT M6		2		
073	265498-0	HEX.SOCKET HEAD BOLT M6X20		1		
074	267314-2	FLAT WASHER 7		1		
075	419118-0	COVER		1		
076	267743-9	SHOLDER WASHER 6		1		
077	344766-5	HOLDER		1		
078	163456-9	SPIRAL SPRING COMPLETE		1		
079	419112-2	SPRING GUIDE		1		
080	256428-2	PIN 5-8		1		
081	262054-7	URETHANE RING 3		1		
082	256770-1	PIN 4		1		
083	419116-4	PUSHER LEVER		1		
084	262054-7	URETHANE RING 3		1		
085	345673-5	LOCK PLATE		1		
086	231309-1	COMPRESSION SPRING 5		1		
087	345621-4	PUSHER		1		
088	233038-2	COMPRESSION SPRING 5		1		
089	256490-7	PIN 4		1		
091	951054-9	SPRING PIN 3-10		1		
092	233908-5	CONICAL COMPRESSION SPRING 4-11		1		
093	810097-9	INDICATION LABEL		1		
094	819181-7	INDICATION LABEL		1		
095	266370-9	HEX SOCKET HEAD BOLT M6X12		1		

A01	122742-7	HOOK ASSEMBLY		1		
C10	233442-5	COMPRESSION SPRING 10		1		
C20	257757-6	SLEEVE 10		1		
C30	313125-4	JOINT		1		
C40	951063-8	SPRING PIN 3-16		1		
A02	192517-8	SAFETY GOGGLE		1	*	
A02-1	195246-2	SAFETY GOGGLE	<	1	*	
A03	181434-7	OIL SUPPLY 30CC		1		
A04	421677-2	NOSE ADAPTER		1		
E01	243104-7	ADAPTER R3/8		1	*	
A05	824841-8	PLASTIC CARRYING CASE		1		

Please state Parts No. when your order.

Print Date 10/11/2023