

Model No.DC40RB TWO PORT MULTI FAST CHARGER

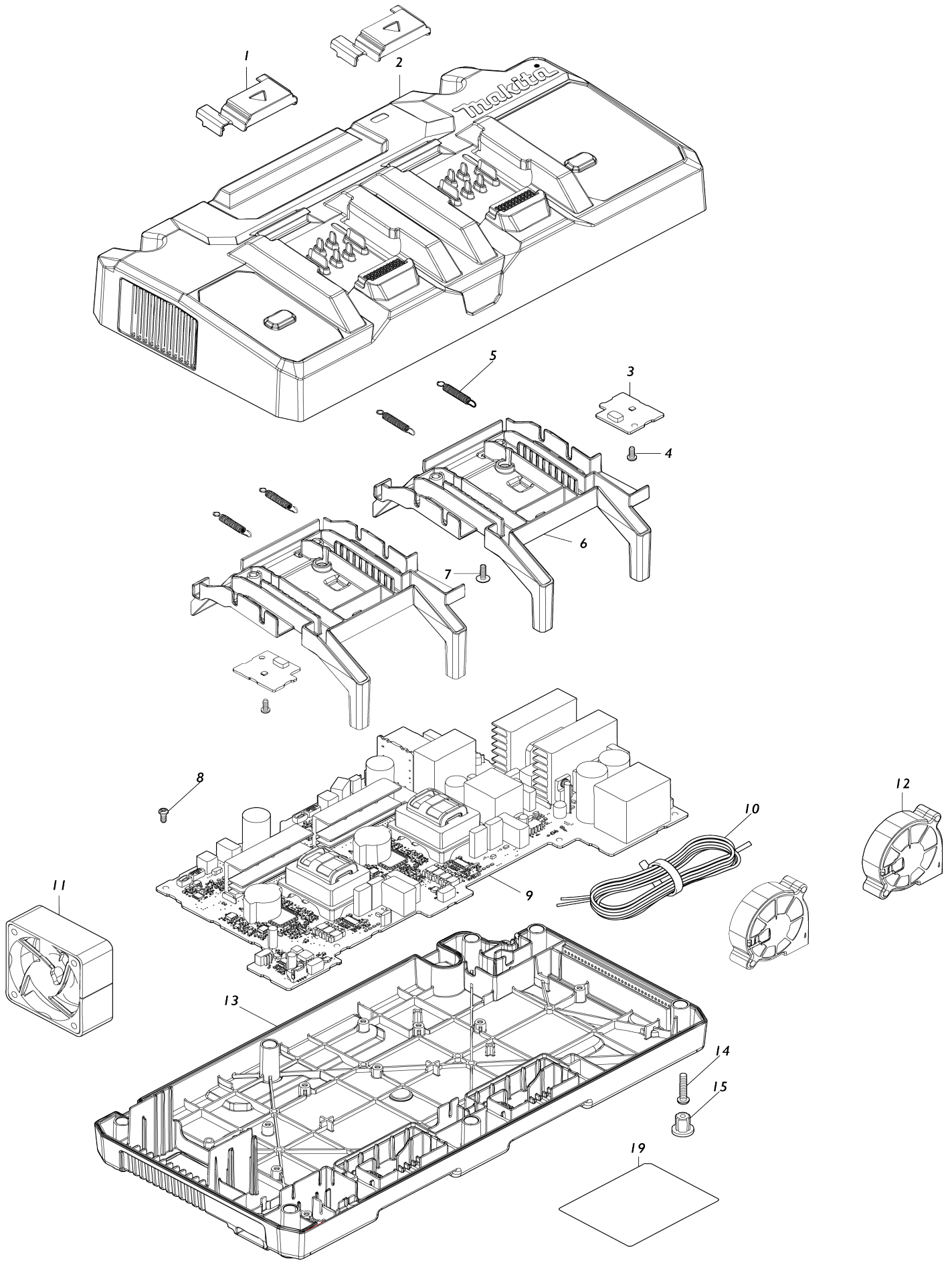

Model No.DC40RB TWO PORT MULTI FAST CHARGER

Item No.	Parts No.	Description	Interchangability	Q'ty	New/Old	Note1	Note2
001	412892-9	TERMINAL COVER		2			
002	140Y57-0	CHARGER CASE COMPLETE		1			
C10	412893-7	LENS		2			
C20	8024W4-1	CHARGING CONDITION LABEL 1		1			
C30	8024W5-9	CHARGING CONDITION LABEL 2		1			
003	620E51-3	LED CIRCUIT		2			
004	266764-8	TAPPING SCREW 3X8		2			
005	232647-4	TENSION SPRING 4		4			
006	412891-1	TERMINAL BASE		2			
007	266278-7	TAPPING SCREW FLANGE BT3X10		6			
008	266764-8	TAPPING SCREW 3X8		9			
009	620E50-5	CHARGING CIRCUIT		1			
C10	647306-1	VARISTOR		1			
C20	652094-7	FUSE		1			
010	667708-5	POWER SUPPLY CORD		1			
011	632R81-0	FAN 60		1			
012	632R80-2	SCIROCCO FAN		2			
013	412890-3	CHARGER CASE COVER		1			
014	266426-8	TAPPING SCREW 4X20		7			
015	286255-3	CAP 13		4			
019	811G31-4	DC40RB NAME PLATE		1			
F01	191N09-8	DC40RB 2PORT FAST CHARGER SET		1			

Please state Parts No. when your order.

Print Date 10/24/2023