

Model No.DTL063 CORDLESS ANGLE IMPACT WRENCH

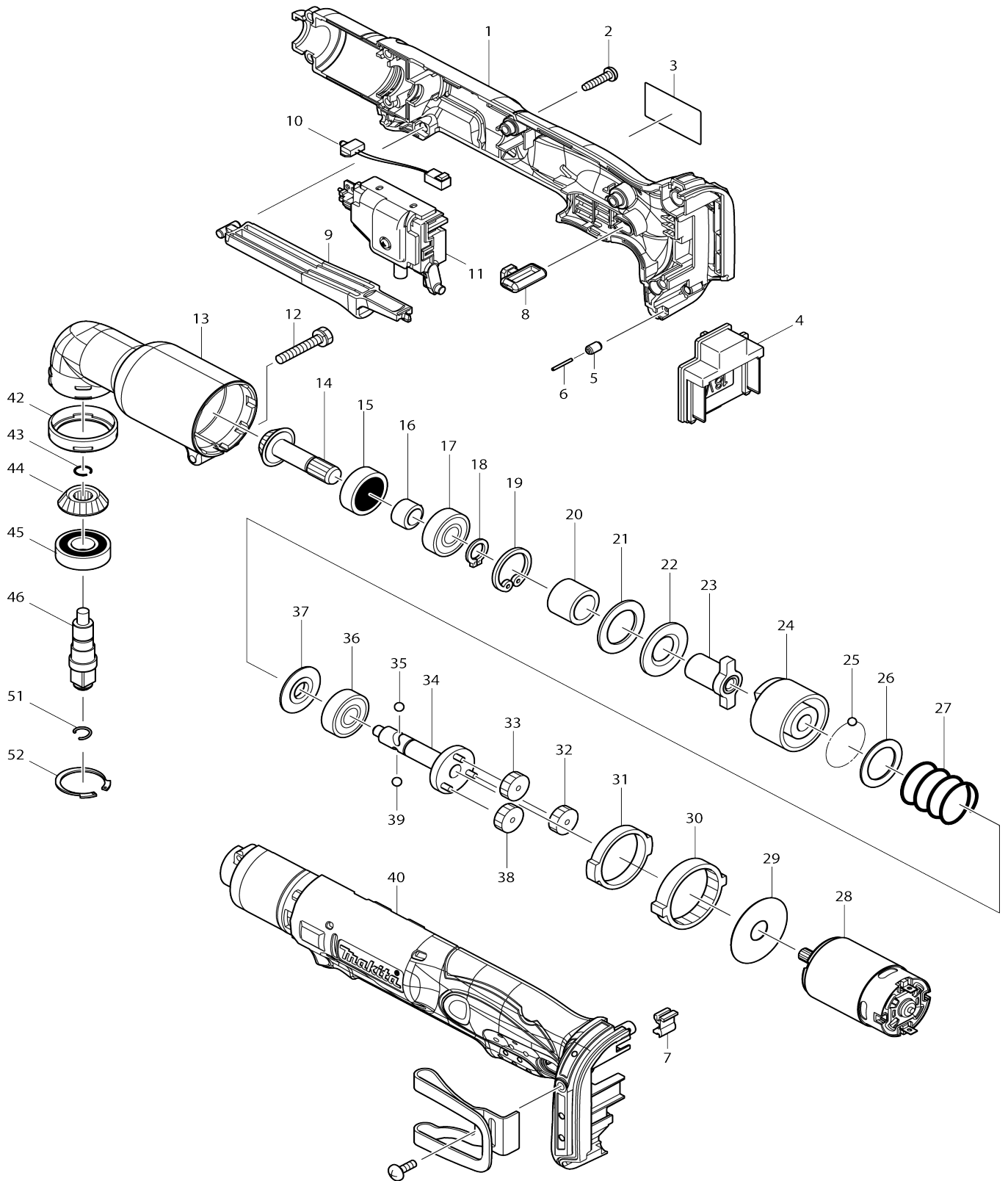

Model No.DTL063 CORDLESS ANGLE IMPACT WRENCH

Item No.	Parts No.	Description	Interchangability	Q'ty	New/Old	Note1	Note2
001	187502-4	HOUSING SET		1			
C10	263005-3	RUBBER PIN 6		2			
D10		INC. 40					
002	265995-6	TAPPING SCREW 4X18		8			
003	815L75-6	DTL063 NAME PLATE		1			
004	643852-2	TERMINAL		1			
005	263036-2	RUBBER PIN 5		1			
006	268184-2	PIN 1.5		1			
007	424026-2	CUSHION		1			
008	450126-2	FR CHANGE LEVER		1			
009	450125-4	SWITCH LEVER		1			
010	631778-0	LED CIRCUIT		1			
011	638884-2	SWITCH UNIT		1			
012	265409-5	+ HEX. BOLT M5X30		1			
013	152461-1	ANGLE HEAD COMPLETE		1			
014	226720-0	ZEROL BEVEL GEAR 13		1	*		
014-1	227A73-6	ZEROL BEVEL GEAR 13	S	1			
015	211064-1	BALL BEARING 6000		1			
016	257660-1	SLEEVE 10		1			
017	211061-7	BALL BEARING 6000LLB		1			
018	961006-2	RETAINING RING S-10		1			
019	962105-3	RETAINING RING R-26		1			
020	257662-7	SLEEVE 15		1			
021	261095-0	RUBBER WASHER 21		1			
022	267120-5	FLAT WASHER 15		1			
023	322689-7	ANVIL		1			
024	322688-9	HAMMER		1			
025	216001-0	STEEL BALL 3.5		22			
026	267121-3	FLAT WASHER 20		1			
027	233107-9	COMPRESSION SPRING 22		1			
028	629966-1	DC MOTOR		1			
029	267053-4	FLAT WASHER 12		1			
030	226280-2	INTERNAL GEAR 69		1			
031	257187-1	RING 32		1			
032	226279-7	SPUR GEAR 29		1			
033	226279-7	SPUR GEAR 29		1			
034	154416-2	SPINDLE COMPLETE		1			
035	216002-8	STEEL BALL 4.8		1			
036	211064-1	BALL BEARING 6000		1			
037	322719-4	WASHER 10		1			
038	226279-7	SPUR GEAR 29		1			
039	216002-8	STEEL BALL 4.8		1			
040	187502-4	HOUSING SET		1			
C10	263005-3	RUBBER PIN 6		2			
D10		INC. 1					
042	424044-0	RUBBER RING 32		1			
043	231990-8	RING SPRING 9		1			

044	226721-8	ZEROL BEVEL GEAR 13		1	*		
044-1	227A74-4	ZEROL BEVEL GEAR 13	S	1			
045	211131-2	BALL BEARING 6001DDW		1			
046	324026-1	SPINDLE		1			
051	231964-9	RING SPRING 7		1			
052	962116-8	RETAINING RING R-28		1			
A01	346317-0	HOOK		1			
A02	251314-2	+ SCREW M4X12		1			
F02	192486-3	STRAIGHT HEAD		0			
C01	231951-8	RING SPRING 11		1			
C06	267085-1	FLAT WASHER 12		1			
C11	233005-7	COMPRESSION SPRING 13		1			
C16	324420-7	SLEEVE		1			
C21	216001-0	STEEL BALL 3.5		2			
C26	322824-7	SPINDLE		1			
C31	211061-7	BALL BEARING 6000LLB		2			
C36	257660-1	SLEEVE 10		1			
C41	962105-3	RETAINING RING R-26		1			
C46	961006-2	RETAINING RING S-10		1			
C51	316603-3	STRAIGHT HEAD		1			
C56	265409-5	+ HEX. BOLT M5X30		1			
F03	192439-2	RATCHET ATTACHMENT SET		1			
C01	265409-5	+ HEX. BOLT M5X30		1			
C06	261098-4	NYLON WASHER 30		1			
C11	962165-5	RETAINING RING R-37		1			
C16	267122-1	FLAT WASHER 27		1			
C21	785070-7	SOCKET 21-31.5		1			
C26	152462-9	RATCHET HOLDER COMPLETE		1			
C31	216017-5	STEEL BALL 16		1			
C36	322716-0	WASHER 8		1			
C41	211103-7	BALL BEARING 6001LB		2			
C46	257661-9	SLEEVE 12		1			
C51	316602-5	RATCHET HEAD		1			
C56	962106-1	RETAINING RING R-28		1			
C61	322715-2	SPINDLE		1			
C66	232137-7	LEAF SPRING		1			
C71	253348-1	THIN WASHER 27		1			
C76	261097-6	NYLON WASHER 27		1			
F10	194654-4	HOOK SET		1			
C10	251314-2	+ SCREW M4X12		1			
C20	324705-1	HOOK		1			
F11	194649-7	BATTERY PROTECTOR		1			
C10	251314-2	+ SCREW M4X12		2			
A03	***DC18RC	DC18RC FAST CHARGER		1			
A04	194204-5	BATTERY BL1830 SET		1	*		
A04-1	194204-5	BATTERY BL1830 SET	O	1	*		
A04-2	197600-6	BATTERY BL1830B SET	<	1	*		
A04-3	197600-6	BATTERY BL1830B SET	O	1			
A05	141493-3	PLASTIC CARRYING CASE		1			
C10	163455-1	LATCH		2			
C20	419360-3	HANDLE		1			
A06	803L52-0	DTL063RF MODEL NO. LABEL		1			

A06	803L53-8	DTL063RFE MODEL NO. LABEL		1			
A07	450128-8	BATTERY COVER		1			
A05	821550-0	CONNECTOR PLASTIC CASE (TYPE2)		1			
C10	453974-8	LATCH		4			
A06	837644-1	INNER TRAY		1			
A08	803L48-1	DTL063RFJ INDICATION LABEL		1			
A09	803L50-4	DTL063RFJ PLASTIC CASE LABEL		2			
A08	803L49-9	DTL063ZJ INDICATION LABEL		1			
A09	803L51-2	DTL063ZJ PLASTIC CASE LABEL		2			

Please state Parts No. when your order.

Print Date 11/20/2023