

Model No.GA4550R 115MM ANGLE GRINDER

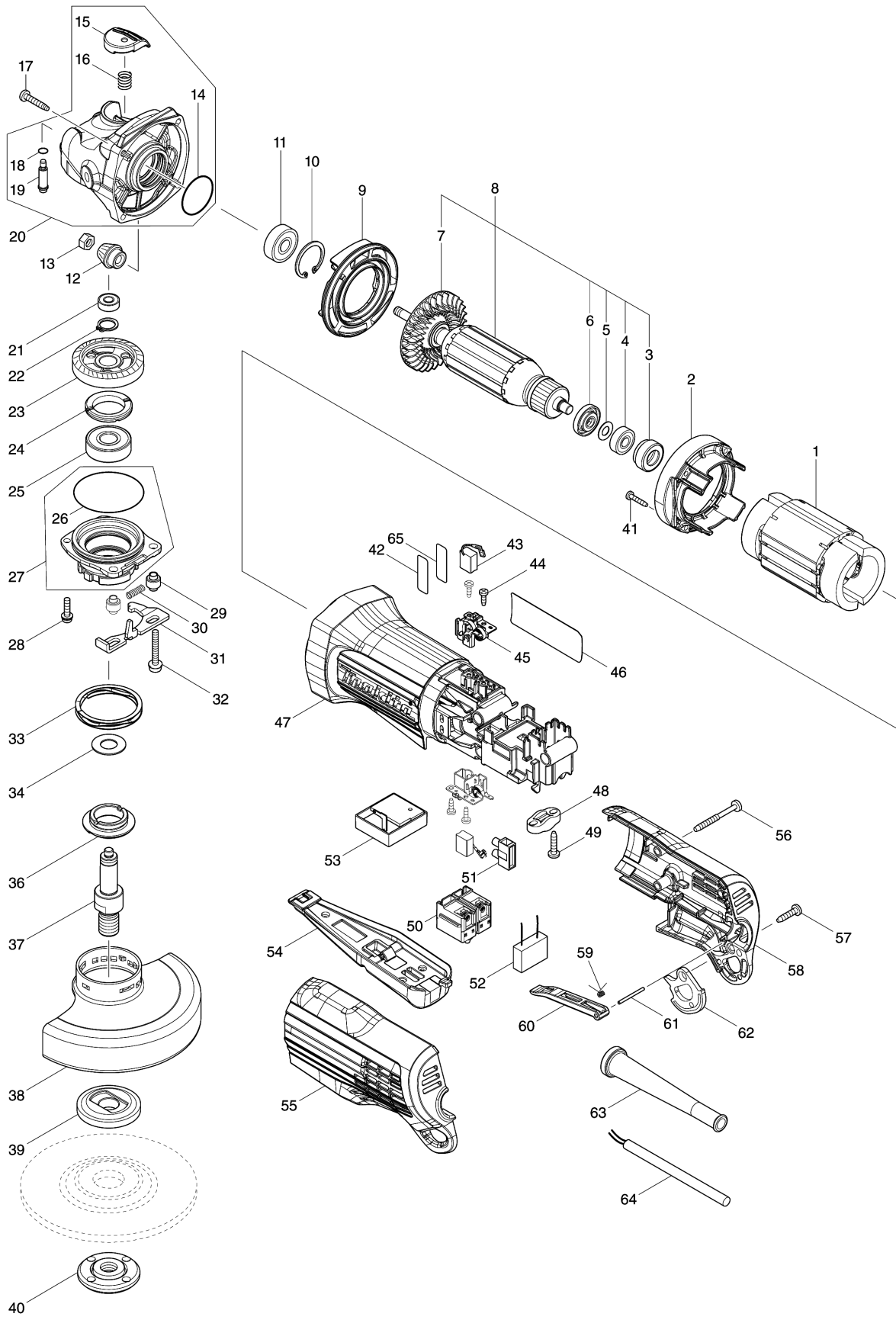

Model No.GA4550R 115MM ANGLE GRINDER

Item	Parts No.	Description	I/C	Qty	New/Old	Opt. 1	Opt. 2	Note
001	634734-9	FIELD		1				
002	459003-5	BAFFLE PLATE		1				
003	422413-9	RUBBER RING 19		1				
004	210017-7	BALL BEARING 607DDW		1				
005	253186-1	FLAT WASHER 7		1				
006	681636-0	INSULATION WASHER		1				
007	240197-5	FAN60		1				
008	518359-6	ARMATURE ASS'Y 220V		1				
D10		INC. 3-7						
009	459004-3	DIFFUSER		1				
010	962105-3	RETAINING RING R-26		1				
011	211092-6	BALL BEARING 629DDW		1				
012	226858-1	SPIRAL BEVEL GEAR 10		1				
013	252186-8	HEX. NUT M6		1				
014	213407-3	O RING 26		1				
015	459006-9	PIN CAP		1				
016	232491-9	COMPRESSION SPRING 9		1				
017	266324-6	TAPPING SCREW 4X22		4	*			
017-1	265B46-7	TAPPING SCREW 4X22	O	4				
018	213877-6	O-RING 6		1				
019	256594-5	SHOULDER PIN 6		1				
020	136144-1	GEAR HOUSING B ASS'Y		1				
C10	263002-9	RUBBER PIN 4		1				
D10		INC. 14-16,18,19						
021	210033-9	BALL BEARING 696ZZ		1				
022	961052-5	RETAINING RING (EXT) S-12		1				
023	226859-9	SPIRAL BEVEL GEAR 37		1				
024	285039-6	BEARING RETAINER 23-33		1				
025	211129-9	BALL BEARING 6201DDW		1				
026	213624-5	O RING 48		1	*			
026-1	213624-5	O RING 48	O	1				
027	136141-7	BEARING BOX A ASS'Y		1				
D10		INC. 26			*			
D11		INC. 26,66						
028	911128-8	P.H.SCREW M4X16 WITH WR		2				
029	327322-6	SLEEVE 4		2				
030	232490-1	COMPRESSION SPRING 4		1				
031	347475-5	LEVER		1				
032	911159-7	PAN HEAD SCREW M4X30		2				
033	232542-8	COILED WAVE SPRING 41		1	*			
034	267238-2	FLAT WASHER 12		1				
036	319789-2	PLATE RETAINER 20		1				
037	327241-6	SPINDLE		1				
038	347479-7	WHEEL COVER 115		1	*			
038-1	141P44-8	WHEEL COVER 115 COMPLETE	<	1				

Please order the parts with part number.

Print Date 19/2/2024

Model No.GA4550R 115MM ANGLE GRINDER

Item	Parts No.	Description	I/C	Qty	New/Old	Opt. 1	Opt. 2	Note
C10	8050A1-8	CAUTION LABEL		1				
039	224490-5	INNER FLANGE 14-45		1				
040	224485-8	LOCK NUT 14-45		1				
041	266429-2	TAPPING SCREW 3X16		4	*			
041-1	266130-9	TAPPING SCREW BIND PT 3X16	O	4				
042	856E41-2	GA4550R SERIAL NO. LABEL		1				
043	191D85-2	CARBON BRUSH SET CB-260		1				
044	266007-8	TAPPING SCREW BIND PT 3X10		4				
045	643541-9	BRUSH HOLDER		2				
046	856E39-9	GA4550R NAME PLATE		1				
047	458999-7	MOTOR HOUSING		1				
048	687124-5	STRAIN RELIEF		1				
049	266326-2	TAPPING SCREW 4X18		2	*			
049-1	265B67-9	TAPPING SCREW 4X18	O	2				
050	650579-7	SWITCH 1246.3223		1	*			
050-1	651396-8	SWITCH FPC-2115S-0-03	<	1				
051	654532-5	TERMINAL BLOCK 1P		2				
052	645190-8	NOISE SUPPRESSOR		1				
053	620951-7	CONTROLLER		1				
054	162540-7	SWITCH LEVER COMPLETE		1				
C10	231679-8	TORSION SPRING 2		1				
C20	459007-7	LOCK OFF LEVER		1	*			
C21	412971-3	LOCK OFF LEVER	<	1				
C30	951019-1	SPRING PIN 2-20		1				
055	183M68-0	REAR COVER SET		1				
D10		INC. 58						
056	266048-4	TAPPING SCREW 4X40		3				
057	266326-2	TAPPING SCREW 4X18		1	*			
057-1	265B67-9	TAPPING SCREW 4X18	O	1				
058	183M68-0	REAR COVER SET		1				
D10		INC. 55						
059	232492-7	TORSION SPRING 2		1				
060	459005-1	SWITCH LINK LEVER		1				
061	256595-3	PIN 2		1				
062	347476-3	STRAP RING		1				
063	682559-5	CORD GUARD 8		1				
064	665394-6	POWER SUPPLY CORD 1.0-2- 2.5		1				
066	213789-3	O-RING 38		1				
A01	158237-4	GRIP 36 COMPLETE		1				
A02	782423-1	LOCK NUT WRENCH 35		1				
A03	199709-0	CUTTING W.C.A. 115 SET		1				
F03	192227-7	SUPER FLANGE		1				
F05	194514-0	VIBRATION PROOF GRIP SET		1				
F18	191W05-0	115/125MM DUST COVER SET		1				

Please order the parts with part number.

Print Date 19/2/2024

Model No.GA4550R 115MM ANGLE GRINDER

Item	Parts No.	Description	I/C	Qty	New/Old	Opt. 1	Opt. 2	Note
C10	743129-6	BRUSH A		1				
C20	743130-1	BRUSH B		1				

Please order the parts with part number.

Print Date 19/2/2024