

Model No.VC2012L VACUUM CLEANER

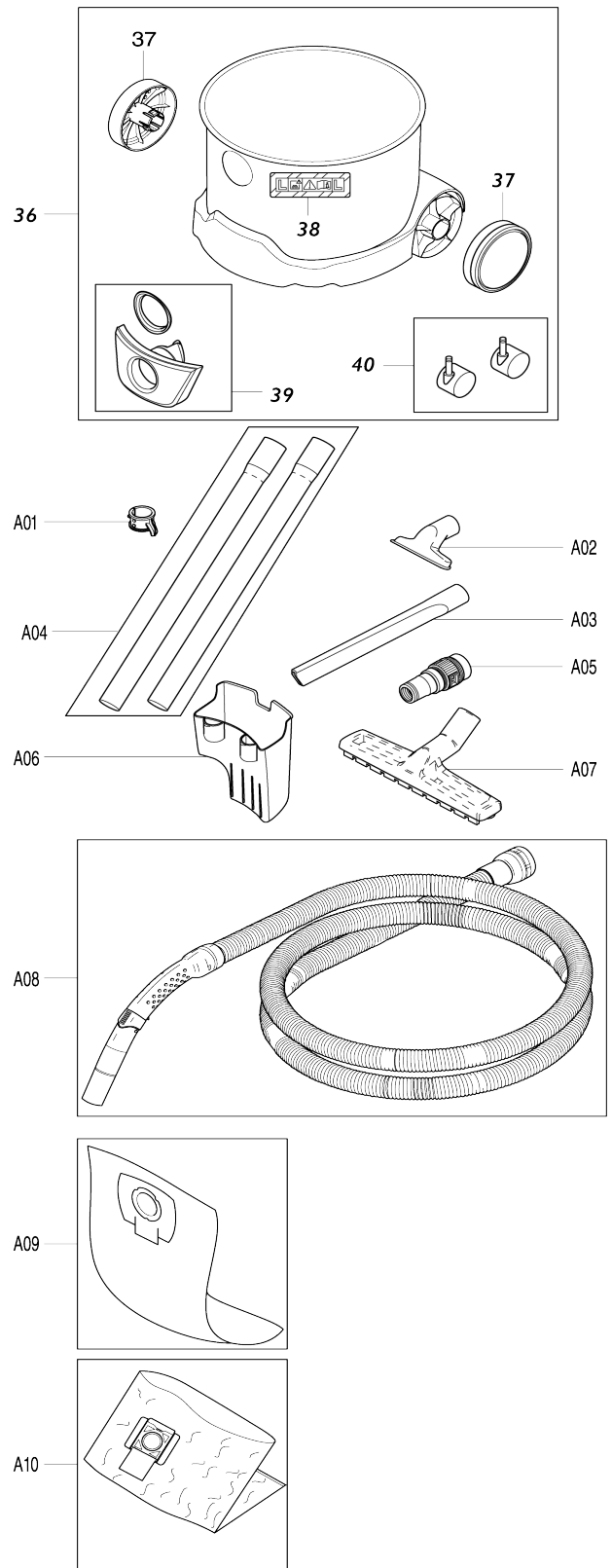
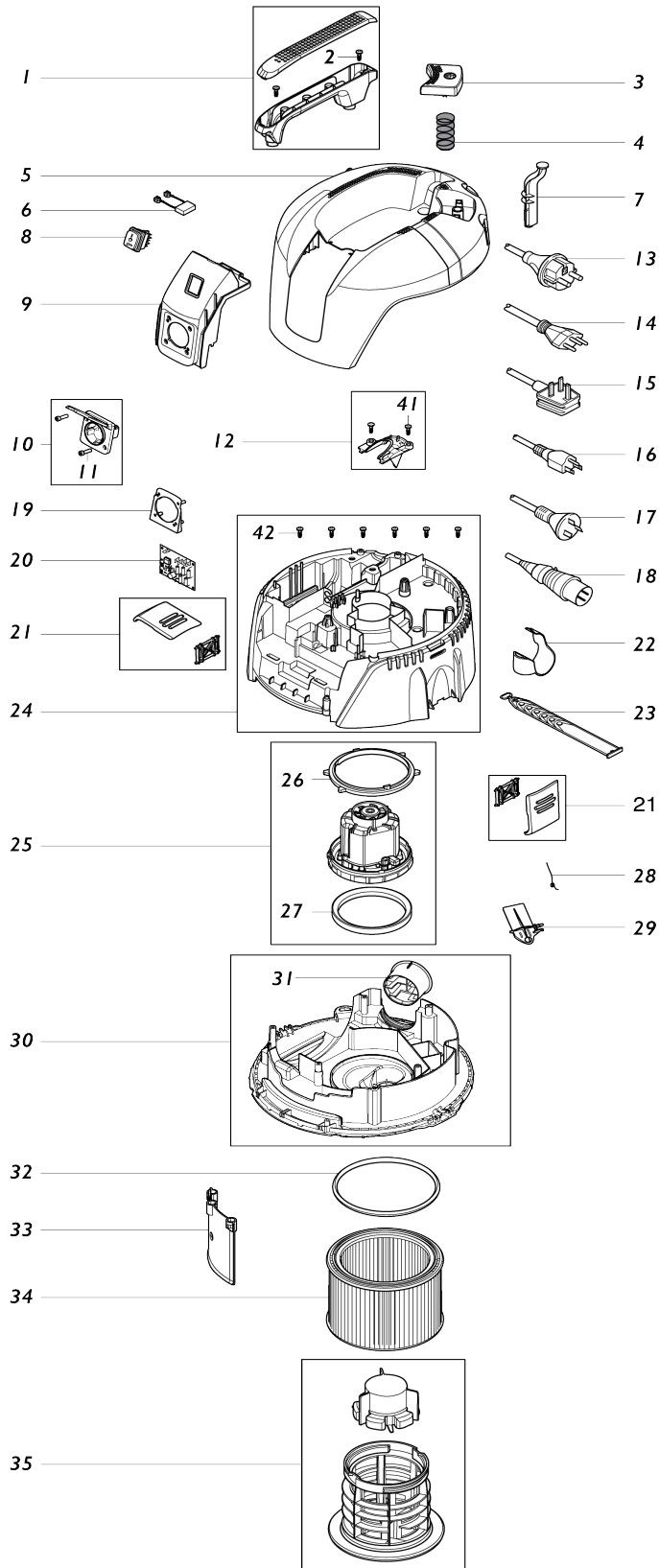

Model No.VC2012L VACUUM CLEANER

Item No.	Parts No.	Description	Interchangeability	Q'ty	New/Old	Note1	Note2
001	W107409137	HANDLE BLACK		1	*		
D10		INC. 2					
001-1	W107411598	HANDLE BLACK	X	1			
D10		INC. 2					
002	W302003704	SCREW 5X18 TX20		2	*		
002-1	W302004029	SCREW 5X18 TX20	O	2			
003	W107409153	DEDUSTING KNOB BLACK		1			
004	W107411345	SPRING FOR DEDUSTING KNOB		1			
005	W107411996	COVER >MAKITA<		1			
006	W107404542	CAPACITOR 0.1 MICRO FARAD		1			
007	W107409141	KIT DEDUSTING ROD		1	*		
007-1	W107411600	KIT DEDUSTING ROD	X	1			
008	W107409135	SWITCH I-0-TOOL		1			
009	W107411997	INTERFACE >MAKITA<		1			
010	W302004034	SOCKET *EU* - CEE7/4		1			
D10		INC. 11					
011	W302004032	SCREW 3,5X18 TX10		2			
012	W107409125	CABLE OUTLET		1			
D10		INC. 41					
013	W107402641	POWER CORD *EU* - CEE7/7		1			
019	W302002052	PLUG SOCKET FIXING PLATE		1			
020	W107409188	ELEKTRONIC 220-240V		1			
021	W107409130	KIT LOCKING CLAMP		2			
022	W107402799	HOSE CLAMP		1			
023	W107409131	RUBBER STRAP		1			
024	W107409132	CLAMPING PLATE		1			
D10		INC. 42					
025	W107409160	MOTOR 220-240V 1000 W		1			
D10		INC. 26,27					
026	W107409163	UPPER MOTOR SEALING		1			
027	W107409164	LOWER MOTOR SEALING		1			
028	W909100083	TORSION SPRING		1			
029	W107409129	DEDUSTING FLAP		1			
030	W107409166	BASE PLATE WITH AIR OUTLET		1			
D10		INC. 31					
031	W107409167	AIR OUTLET		1			
032	W107409165	SEALING FILTER		1			
033	W107409159	DEFLECTOR SHIELD		1			
034	P-70219	FILTER ELEMENT		1			
035	W302002042	FILTER ELEMENT RETAINER		1	*		
035-1	W107402646	KIT FILTER SUPPORT CAGE +FLO AT	X	1			
036	W107411998	CONTAINER 20L INOX >MAKITA<		1			
D10		INC. 37-40					
037	W107409170	WHEEL D130		2			
038	W302004200	LABEL >DUST CLASS L<		1			
039	W107410817	INLET FITTING KIT		1			
040	W140642250	KIT CASTOR WHEELS 50MM		1			

041	W302003704	SCREW 5X18 TX20		2	*		
041-1	W302004029	SCREW 5X18 TX20	O	2			
042	W302003704	SCREW 5X18 TX20		6	*		
042-1	W302004029	SCREW 5X18 TX20	O	6			
A01	W107409979	TUBE HOLDER KIT		1			
A02	W142950000	NOZZLE UNIVERSAL		1			
A03	W295410000	CREVICE NOZZLE		1			
A04	P-72942	SUCTION TUBE 35X520MM 2PCS.		1			
A05	W107409977	TOOL ADAPTER WITH REGULATI ON		1	*		
A05-1	P-81745	TOOL ADAPTER WITH REGULATI ON	<	1			
A06	W107409980	TOOLBOX		1			
A07	W107402706	FLOOR NOZZLE 36X260MM		1			
A08	W107406115	SUCTION HOSE 32X3500MM		1	*		
A08-1	P-81739	SUCTION HOSE D32X3500 W/TU BE	X	1			
C10	W107413340	HAND TUBE WITH REGULATION		1			
A09	P-72899	FILTER BAG		1			
A10	P-70297	DISPOSAL BAG		1			
A11	W107418661	TOOL ADAPTOR 22 QUICK SET		1			
A12	W107418680	TOOL ADAPTOR 38 VC2012-3011 L		1			

Please state Parts No. when your order.

Print Date 26/10/2023