

Model No.VR004G CORDLESS CONCRETE VIBRATOR

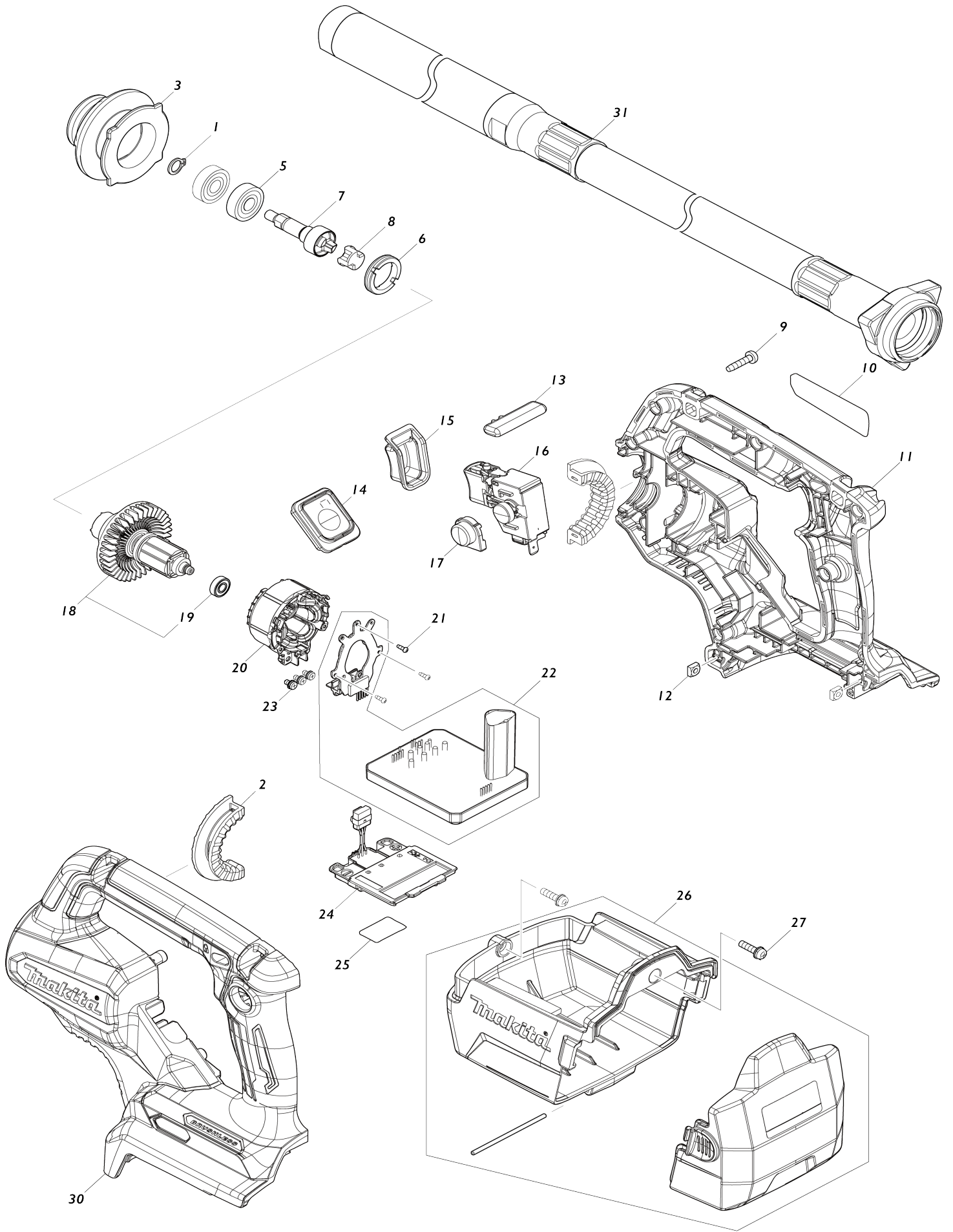

Model No.VR004G CORDLESS CONCRETE VIBRATOR

Item No.	Parts No.	Description	Interchangability	Q'ty	New/Old	Note1	Note2
001	961005-4	RETAINING RING S-9		1			
002	422910-5	RUBBER RING		2			
003	313434-1	HOSE HOLDER		1			
005	210051-7	BALL BEARING 609LLB		2			
006	285053-2	BEARING RETAINER 19-26		1			
007	141K76-5	SPINDLE COMPLETE		1			
008	424833-3	SPACER		1			
009	266045-0	TAPPING SCREW 4X20		11			
010	858L76-1	VR004G NAME PLATE		1			
011	183V84-6	HOUSING SET		1			
C10	8005T5-8	XGT LOGO LABEL		1			
C20	263005-3	RUBBER PIN 6		2			
D10		INC. 30					
012	252173-7	SQUARE NUT		2			
013	458822-6	LOCK LEVER		1			
014	141K86-2	SWITCH CIRCUIT COMPLETE		1			
C10	8055V0-7	SWITCH LABEL		1			
015	422966-8	SWITCH COVER		1			
016	651493-0	SWITCH C3JW-4CM-1L		1			
017	458819-5	LOCK ON BUTTON COVER		1			
018	136692-0	ROTOR ASS'Y		1			
D10		INC. 19					
019	210039-7	BALL BEARING 695DDW		1			
020	629B21-1	STATOR		1			
021	266490-9	TAPPING SCREW PT 2X6		3			
022	620H52-9	CONTROLLER		1			
C10	688163-8	LINE FILTER		1			
C20	688164-6	LINE FILTER		2			
023	652069-6	FLAT HEAD SCREW M3X6		3			
024	632P65-6	TERMINAL UNIT		1			
025	858L80-0	VR004G SERIAL NO. LABEL		1			
026	136704-9	BATTERY CASE S ASS'Y		1	*		
C10	816B52-1	CAUTION LABEL		1	*		
C20	810196-7	CAUTION LABEL		1	*		
026-1	136901-7	BATTERY CASE L ASS'Y	<	1			
C10	816B52-1	CAUTION LABEL		1			
C20	810196-7	CAUTION LABEL		1			
027	911128-8	P.H.SCREW M4X16 WITH WR		2			
030	183V84-6	HOUSING SET		1			
C10	8005T5-8	XGT LOGO LABEL		1			
C20	263005-3	RUBBER PIN 6		2			
D10		INC. 11					
031	1910E3-1	FLEXIBLE SHAFT 38-1.2 SET		1			
C10	HA00000307	SHAFT (1.0M)		1			
A01	781213-9	WRENCH 8		1			
F01	1910C2-9	FLEXIBLE SHAFT 32-2.4 SET		1			
C10	HA00000309	SHAFT (2.0M)		1			

F02	1910C4-5	FLEXIBLE SHAFT 38-2.4 SET		1		
C10	HA00000309	SHAFT (2.0M)		1		
F03	1910E1-5	FLEXIBLE SHAFT 32-1.2 SET		1		
C10	HA00000307	SHAFT (1.0M)		1		
F04	1910E2-3	FLEXIBLE SHAFT 32-1.7 SET		1		
C10	HA00000308	SHAFT (1.5M)		1		
F05	1910E3-1	FLEXIBLE SHAFT 38-1.2 SET		1		
C10	HA00000307	SHAFT (1.0M)		1		
F07	1910J4-4	BATTERY CASE H SET		1		
F09	1910J1-0	BATTERY CASE L SET		1		

Please state Parts No. when your order.

Print Date 26/10/2023