

INSTRUCTION MANUAL

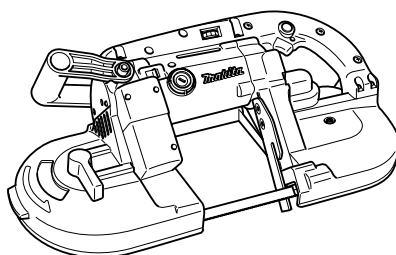

Portable Band Saw

2107F



005893

 DOUBLE INSULATION

IMPORTANT: Read Before Using.

ENGLISH (Original instructions)

SPECIFICATIONS

Model		2107F
Max. cutting capacity	Round workpiece	120 mm dia.
	Rectangular workpiece	120 mm x 120 mm
Blade speed		1.0 - 1.7 m/s
Blade size	Length	1,140 mm
	Width	13 mm
	Thickness	0.5 mm
Overall dimensions	H x W x L	496 mm x 184 mm x 249 mm
Net weight		6.0 kg
Safety class		□/II

- Due to our continuing program of research and development, the specifications herein are subject to change without notice.
- Specifications may differ from country to country.
- Weight according to EPTA-Procedure 01/2003

END201-7

GEA005-3

Symbols

The following show the symbols used for the equipment. Be sure that you understand their meaning before use.



- Read instruction manual.



- DOUBLE INSULATION



- Only for EU countries
Do not dispose of electric equipment together with household waste material! In observance of the European Directive, on Waste Electric and Electronic Equipment and its implementation in accordance with national law, electric equipment that have reached the end of their life must be collected separately and returned to an environmentally compatible recycling facility.

ENE009-1

Intended use

The tool is intended for cutting in wood, plastic and ferrous materials.

ENF002-2

Power supply

The tool should be connected only to a power supply of the same voltage as indicated on the nameplate, and can only be operated on single-phase AC supply. They are double-insulated and can, therefore, also be used from sockets without earth wire.

General Power Tool Safety Warnings

⚠ WARNING Read all safety warnings and all instructions. Failure to follow the warnings and instructions may result in electric shock, fire and/or serious injury.

Save all warnings and instructions for future reference.

The term "power tool" in the warnings refers to your mains-operated (corded) power tool or battery-operated (cordless) power tool.

Work area safety

1. **Keep work area clean and well lit.** Cluttered or dark areas invite accidents.
2. **Do not operate power tools in explosive atmospheres, such as in the presence of flammable liquids, gases or dust.** Power tools create sparks which may ignite the dust or fumes.
3. **Keep children and bystanders away while operating a power tool.** Distractions can cause you to lose control.

Electrical safety

4. **Power tool plugs must match the outlet. Never modify the plug in any way. Do not use any adapter plugs with earthed (grounded) power tools.** Unmodified plugs and matching outlets will reduce risk of electric shock.
5. **Avoid body contact with earthed or grounded surfaces such as pipes, radiators, ranges and refrigerators.** There is an increased risk of electric shock if your body is earthed or grounded.
6. **Do not expose power tools to rain or wet conditions.** Water entering a power tool will increase the risk of electric shock.

7. **Do not abuse the cord. Never use the cord for carrying, pulling or unplugging the power tool. Keep cord away from heat, oil, sharp edges or moving parts.** Damaged or entangled cords increase the risk of electric shock.
8. **When operating a power tool outdoors, use an extension cord suitable for outdoor use.** Use of a cord suitable for outdoor use reduces the risk of electric shock.
9. **If operating a power tool in a damp location is unavoidable, use a residual current device (RCD) protected supply.** Use of an RCD reduces the risk of electric shock.
10. **Use of power supply via a RCD with a rated residual current of 30 mA or less is always recommended.**

Personal safety

11. **Stay alert, watch what you are doing and use common sense when operating a power tool. Do not use a power tool while you are tired or under the influence of drugs, alcohol or medication.** A moment of inattention while operating power tools may result in serious personal injury.
12. **Use personal protective equipment. Always wear eye protection.** Protective equipment such as dust mask, non-skid safety shoes, hard hat, or hearing protection used for appropriate conditions will reduce personal injuries.
13. **Prevent unintentional starting. Ensure the switch is in the off-position before connecting to power source and/or battery pack, picking up or carrying the tool.** Carrying power tools with your finger on the switch or energising power tools that have the switch on invites accidents.
14. **Remove any adjusting key or wrench before turning the power tool on.** A wrench or a key left attached to a rotating part of the power tool may result in personal injury.
15. **Do not overreach. Keep proper footing and balance at all times.** This enables better control of the power tool in unexpected situations.
16. **Dress properly. Do not wear loose clothing or jewellery. Keep your hair, clothing, and gloves away from moving parts.** Loose clothes, jewellery or long hair can be caught in moving parts.
17. **If devices are provided for the connection of dust extraction and collection facilities, ensure these are connected and properly used.** Use of dust collection can reduce dust-related hazards.

Power tool use and care

18. **Do not force the power tool. Use the correct power tool for your application.** The correct power tool will do the job better and safer at the rate for which it was designed.
19. **Do not use the power tool if the switch does not turn it on and off.** Any power tool that cannot be controlled with the switch is dangerous and must be repaired.
20. **Disconnect the plug from the power source and/or the battery pack from the power tool before making any adjustments, changing accessories, or storing power tools.** Such preventive safety measures reduce the risk of starting the power tool accidentally.
21. **Store idle power tools out of the reach of children and do not allow persons unfamiliar with the power tool or these instructions to operate the power tool.** Power tools are dangerous in the hands of untrained users.
22. **Maintain power tools. Check for misalignment or binding of moving parts, breakage of parts and any other condition that may affect the power tool's operation. If damaged, have the power tool repaired before use.** Many accidents are caused by poorly maintained power tools.
23. **Keep cutting tools sharp and clean.** Properly maintained cutting tools with sharp cutting edges are less likely to bind and are easier to control.
24. **Use the power tool, accessories and tool bits etc. in accordance with these instructions, taking into account the working conditions and the work to be performed.** Use of the power tool for operations different from those intended could result in a hazardous situation.

Service

25. **Have your power tool serviced by a qualified repair person using only identical replacement parts.** This will ensure that the safety of the power tool is maintained.
26. **Follow instruction for lubricating and changing accessories.**
27. **Keep handles dry, clean and free from oil and grease.**

GEB005-5

PORTABLE BAND SAW SAFETY WARNINGS

1. **Hold power tool by insulated gripping surfaces, when performing an operation where the cutting accessory may contact hidden wiring or its own cord.** Cutting accessories contacting a "live" wire may make exposed metal parts of the power tool "live" and could give the operator an electric shock.

2. Use only blades which are 1,140 mm (44-7/8") long, 13 mm (1/2") wide, and 0.5 mm (0.020") thick.
3. Check the blade carefully for cracks or damage before operation. Replace cracked or damaged blade immediately.
4. Secure the workpiece firmly. When cutting a bundle of workpieces, be sure that all workpieces are secured together firmly before cutting.
5. Cutting workpieces covered with oil can cause the blade to come off unexpectedly. Wipe off all excess oil from workpieces before cutting.
6. Never use the cutting oil as a cutting lubricant. Use only Makita cutting wax.
7. Do not wear gloves during operation.
8. Hold the tool firmly with both hands.
9. Keep hands away from rotating parts.
10. When cutting metal, be cautious of hot flying chips.
11. Do not leave the tool running unattended.
12. Do not touch the blade or the workpiece immediately after operation; they may be extremely hot and could burn your skin.

SAVE THESE INSTRUCTIONS.

⚠WARNING:

DO NOT let comfort or familiarity with product (gained from repeated use) replace strict adherence to safety rules for the subject product. MISUSE or failure to follow the safety rules stated in this instruction manual may cause serious personal injury.

FUNCTIONAL DESCRIPTION

⚠CAUTION:

- Always be sure that the tool is switched off and unplugged before adjusting or checking function on the tool.

Switch action

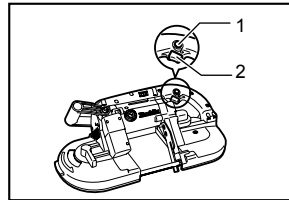

1. Lock button
2. Switch trigger

005894

⚠CAUTION:

- Before plugging in the tool, always check to see that the switch trigger actuates properly and returns to the "OFF" position when released.

To start the tool, simply pull the switch trigger. Release the switch trigger to stop.

For continuous operation, pull the switch trigger and then push in the lock button.

To stop the tool from the locked position, pull the switch trigger fully, then release it.

Speed adjusting dial

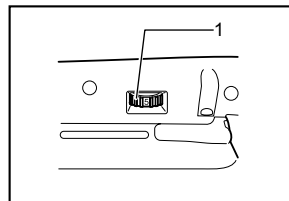

1. Speed adjusting dial

005896

The tool speed can be infinitely adjusted between 1.0 m/s and 1.7 m/s by turning the adjusting dial. Higher speed is obtained when the dial is turned in the direction of number 5; lower speed is obtained when it is turned in the direction of number 1.

Select the proper speed for the workpiece to be cut.

⚠CAUTION:

- The speed adjusting dial can be turned only as far as 5 and back to 1. Do not force it past 5 or 1, or the speed adjusting function may no longer work.

Lighting up the lamps

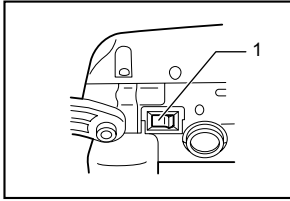

005897

⚠CAUTION:

- Do not apply impact to the light, which may cause damage or shorten service time to it.
- To turn on the lamp, press the "I"(ON) side of the lamp switch. Press the "O"(OFF) side to turn it off.

NOTE:

- Use a dry cloth to wipe the dirt off the lens of lamp. Be careful not to scratch the lens of lamp, or it may lower the illumination.
- Do not use thinner or gasoline to clean the lamp. Such solvents may damage it.
- After operation, always turn off the light by pressing the "O (OFF)" side.

ASSEMBLY

⚠CAUTION:

- Always be sure that the tool is switched off and unplugged before carrying out any work on the tool.

Installing or removing the blade

⚠CAUTION:

- Oil on the blade can cause the blade to slip or come off unexpectedly. Wipe off all excess oil with a cloth before installing the blade.
- Use caution when handling the blade so that you are not cut by the sharp edge of the blade teeth.

Turn the blade tightening lever clockwise until it hits against the protrusion on the frame.

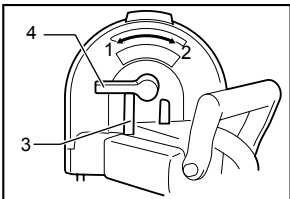

005898

Match the direction of the arrow on the blade to that of the arrow on the wheels.

1. Lamp switch

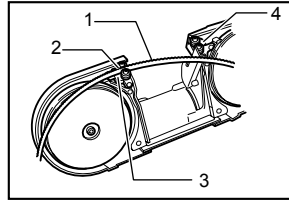

005900

Insert the blade between the bearings of the upper holder first and then into the lower holder. The blade back should contact the bearings in the lower portion of the upper holder and lower holder.

Position the blade around the wheels and insert the other side of the blade within the upper holder and lower holder until the blade back contacts the bottom of the upper holder and lower holder.

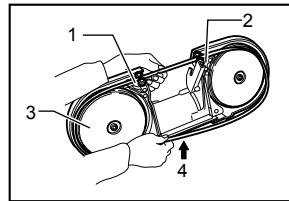

005901

1. Upper holder
2. Lower holder
3. Wheel
4. Press

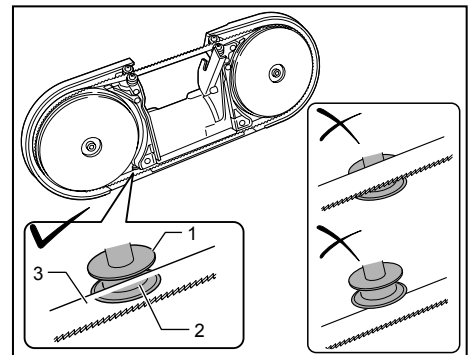

1. Blade guide
2. Groove
3. Blade

015673

Put the blade into the groove in the blade guide.

Hold the blade in place and turn the blade-tightening lever counterclockwise until it hits against the protrusion on the frame. This places proper tension on the blade. Make sure that the blade is correctly positioned within the blade guard and around the wheels.

Start and stop the tool two or three times to make sure that the blade runs properly on the wheels.

⚠CAUTION:

- While making sure that the blade runs on the wheels properly, keep your body away from the blade area.

To remove the blade, follow the installation procedure in reverse.

⚠CAUTION:

- When turning the blade tightening lever clockwise to release the tension on the blade, point the tool downward because the blade may come off unexpectedly.

Adjusting the protrusion of stopper plate

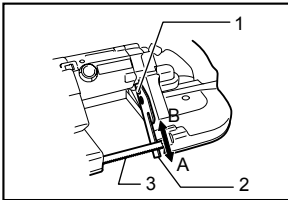

1. Screw
2. Stopper plate
3. Blade

005902

In the ordinary operation, protrude the stopper plate to the A side fully.

When the stopper plate strikes against the obstacles like a wall or the like at the finishing of a cut, loosen two screws and slide it to the B side in the figure.

After sliding the stopper plate, secure it by tightening two screws firmly.

OPERATION

It is important to keep at least two teeth in the cut. Select the proper cutting position for your workpiece by referring to the figure.

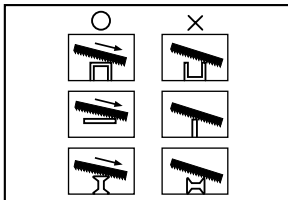

004747

Hold the tool by both hands as shown in the figure with the stopper plate contacting the workpiece and the blade clear of the workpiece.

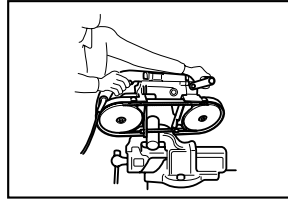

005916

Turn the tool on and wait until the blade attains full speed. Gently lower the blade into the cut. The weight of the tool or slightly pressing the tool will supply adequate pressure for the cutting. Do not force the tool.

As you reach the end of a cut, release pressure and, without actually raising the tool, lift it slightly so that it will not fall against the workpiece.

⚠CAUTION:

- Applying excessive pressure to the tool or twisting of the blade may cause bevel cutting or damage to the blade.
- When not using the tool for a long period of time, remove the blade from the tool.

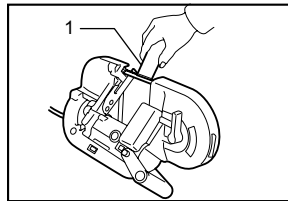

1. Cutting wax

005903

When cutting metals, use Makita cutting wax as a cutting lubricant. To apply the cutting wax to the blade teeth, start the tool and cut in to the cutting wax as shown in the figure after removing a cap of the cutting wax.

⚠CAUTION:

- Never use cutting oil or apply excessive amount of wax to the blade. It may cause the blade to slip or come off unexpectedly.
- When cutting cast iron, do not use any cutting wax.

MAINTENANCE

⚠CAUTION:

- Always be sure that the tool is switched off and unplugged before attempting to perform inspection or maintenance.
- Never use gasoline, benzine, thinner, alcohol or the like. Discoloration, deformation or cracks may result.

Cleaning

After use, remove wax, chips and dust from the tool, wheel tires and blade.

⚠CAUTION:

- Never use solvents such as turpentine, gasoline, lacquer, etc. to clean plastic parts.
- Wax and chips on the tires may cause the blade to slip and come off unexpectedly. Use a dry cloth to remove wax and chips from the tires.

Replacing tires on wheels

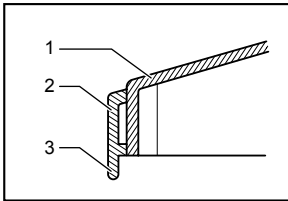

1. Wheel
2. Tire
3. Lip

004750

When the blade slips or does not track properly because of badly worn tires, or the lip of the tire on motor side gets damaged, the tires should be replaced.

Replacing fluorescent tube

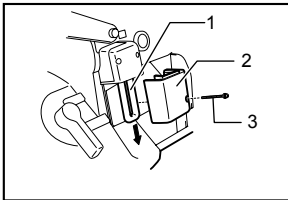

1. Fluorescent tube
2. lamp box
3. Tapping screw

005905

⚠CAUTION:

- Always be sure that the tool is switched off and unplugged before replacing the fluorescent tube.
- Do not apply force, impact or scratch to a fluorescent tube, which can cause a glass of the fluorescent tube to be broken resulting in a injury to you or your bystanders.
- Leave the fluorescent tube for a while immediately after a use of it and then replace it. If not. You may burn yourself.

Remove screws, which secure Lamp Box for the light. Pull out the Lamp Box keeping pushing lightly the upper position of it as illustrated on the left.

Pull out the fluorescent tube and then replace it with Makita original new one.

Replacing carbon brushes

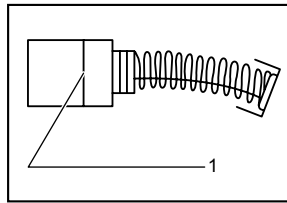

1. Limit mark

001145

Remove and check the carbon brushes regularly. Replace when they wear down to the limit mark. Keep the carbon brushes clean and free to slip in the holders. Both carbon brushes should be replaced at the same time. Use only identical carbon brushes.

Use a screwdriver to remove the brush holder caps. Take out the worn carbon brushes, insert the new ones and secure the brush holder caps.

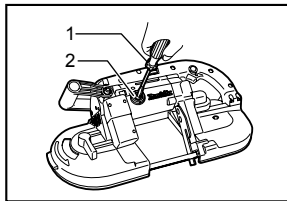

1. Screwdriver
2. Brush holder cap

005906

To maintain product SAFETY and RELIABILITY, repairs, any other maintenance or adjustment should be performed by Makita Authorized Service Centers, always using Makita replacement parts.

OPTIONAL ACCESSORIES

⚠CAUTION:

- These accessories or attachments are recommended for use with your Makita tool specified in this manual. The use of any other accessories or attachments might present a risk of injury to persons. Only use accessory or attachment for its stated purpose.

If you need any assistance for more details regarding these accessories, ask your local Makita Service Center.

- Band saw blades
- Hex wrench 4
- Cutting wax
- Portable band saw stand

NOTE:

- Some items in the list may be included in the tool package as standard accessories. They may differ from country to country.

Makita Corporation