

INSTRUCTION MANUAL

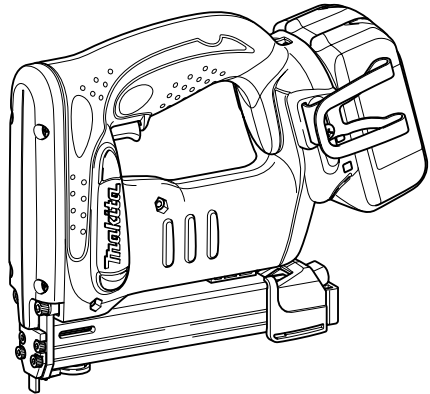

Cordless Stapler

DST220
DST221



014799

IMPORTANT: Read Before Using.

ENGLISH (Original instructions)

SPECIFICATIONS

Model	DST220	DST221
Staple width	10 mm	10 mm
Applicable staples length	10 mm - 22 mm	10 mm - 22 mm
Staple magazine capacity	84 pcs	84 pcs
Overall length	247 mm	251 mm
Net weight	2.3 kg	2.4 kg
Rated voltage	D.C. 14.4 V	D.C. 18 V

- Due to our continuing program of research and development, the specifications herein are subject to change without notice.
- Specifications and battery cartridge may differ from country to country.
- Weight, with battery cartridge, according to EPTA-Procedure 01/2003

END004-3

Symbols

The following show the symbols used for the equipment. Be sure that you understand their meaning before use.



- Read instruction manual.



- Only for EU countries

Do not dispose of electric equipment together with household waste material! In observance of European Directive 2002/96/EC on waste electric and electronic equipment and its implementation in accordance with national law, electric equipment that have reached the end of their life must be collected separately and returned to an environmentally compatible recycling facility.

ENE054-1

Intended use

The tool is intended for pressing staples into construction materials such as timbers.

GEA006-2

General Power Tool Safety

Warnings

⚠ WARNING Read all safety warnings and all instructions. Failure to follow the warnings and instructions may result in electric shock, fire and/or serious injury.

Save all warnings and instructions for future reference.

The term "power tool" in the warnings refers to your mains-operated (corded) power tool or battery-operated (cordless) power tool.

Work area safety

1. **Keep work area clean and well lit.** Cluttered or dark areas invite accidents.
2. **Do not operate power tools in explosive atmospheres, such as in the presence of flammable liquids, gases or dust.** Power tools create sparks which may ignite the dust or fumes.
3. **Keep children and bystanders away while operating a power tool.** Distractions can cause you to lose control.

Electrical safety

4. **Power tool plugs must match the outlet. Never modify the plug in any way. Do not use any adapter plugs with earthed (grounded) power tools.** Unmodified plugs and matching outlets will reduce risk of electric shock.
5. **Avoid body contact with earthed or grounded surfaces such as pipes, radiators, ranges and refrigerators.** There is an increased risk of electric shock if your body is earthed or grounded.
6. **Do not expose power tools to rain or wet conditions.** Water entering a power tool will increase the risk of electric shock.
7. **Do not abuse the cord. Never use the cord for carrying, pulling or unplugging the power tool. Keep cord away from heat, oil, sharp edges or moving parts.** Damaged or entangled cords increase the risk of electric shock.
8. **When operating a power tool outdoors, use an extension cord suitable for outdoor use.** Use of a cord suitable for outdoor use reduces the risk of electric shock.
9. **If operating a power tool in a damp location is unavoidable, use a ground fault circuit interrupter (GFCI) protected supply.** Use of an GFCI reduces the risk of electric shock.

Personal safety

10. **Stay alert, watch what you are doing and use common sense when operating a power tool. Do not use a power tool while you are tired or**

under the influence of drugs, alcohol or medication. A moment of inattention while operating power tools may result in serious personal injury.

11. **Use personal protective equipment. Always wear eye protection.** Protective equipment such as dust mask, non-skid safety shoes, hard hat, or hearing protection used for appropriate conditions will reduce personal injuries.
12. **Prevent unintentional starting. Ensure the switch is in the off-position before connecting to power source and/or battery pack, picking up or carrying the tool.** Carrying power tools with your finger on the switch or energising power tools that have the switch on invites accidents.
13. **Remove any adjusting key or wrench before turning the power tool on.** A wrench or a key left attached to a rotating part of the power tool may result in personal injury.
14. **Do not overreach. Keep proper footing and balance at all times.** This enables better control of the power tool in unexpected situations.
15. **Dress properly. Do not wear loose clothing or jewellery. Keep your hair, clothing, and gloves away from moving parts.** Loose clothes, jewellery or long hair can be caught in moving parts.
16. **If devices are provided for the connection of dust extraction and collection facilities, ensure these are connected and properly used.** Use of dust collection can reduce dust-related hazards.

Power tool use and care

17. **Do not force the power tool. Use the correct power tool for your application.** The correct power tool will do the job better and safer at the rate for which it was designed.
18. **Do not use the power tool if the switch does not turn it on and off.** Any power tool that cannot be controlled with the switch is dangerous and must be repaired.
19. **Disconnect the plug from the power source and/or the battery pack from the power tool before making any adjustments, changing accessories, or storing power tools.** Such preventive safety measures reduce the risk of starting the power tool accidentally.
20. **Store idle power tools out of the reach of children and do not allow persons unfamiliar with the power tool or these instructions to operate the power tool.** Power tools are dangerous in the hands of untrained users.
21. **Maintain power tools. Check for misalignment or binding of moving parts, breakage of parts and any other condition that may affect the**

power tool's operation. If damaged, have the power tool repaired before use. Many accidents are caused by poorly maintained power tools.

22. **Keep cutting tools sharp and clean.** Properly maintained cutting tools with sharp cutting edges are less likely to bind and are easier to control.
23. **Use the power tool, accessories and tool bits etc. in accordance with these instructions, taking into account the working conditions and the work to be performed.** Use of the power tool for operations different from those intended could result in a hazardous situation.

Battery tool use and care

24. **Recharge only with the charger specified by the manufacturer.** A charger that is suitable for one type of battery pack may create a risk of fire when used with another battery pack.
25. **Use power tools only with specifically designated battery packs.** Use of any other battery packs may create a risk of injury and fire.
26. **When battery pack is not in use, keep it away from other metal objects, like paper clips, coins, keys, nails, screws or other small metal objects, that can make a connection from one terminal to another.** Shorting the battery terminals together may cause burns or a fire.
27. **Under abusive conditions, liquid may be ejected from the battery; avoid contact. If contact accidentally occurs, flush with water. If liquid contacts eyes, additionally seek medical help.** Liquid ejected from the battery may cause irritation or burns.

Service

28. **Have your power tool serviced by a qualified repair person using only identical replacement parts.** This will ensure that the safety of the power tool is maintained.
29. **Follow instruction for lubricating and changing accessories.**
30. **Keep handles dry, clean and free from oil and grease.**

ENB069-1

ADDITIONAL SAFETY RULES FOR TOOL

1. **Always wear safety goggles or safety glasses with side shield, and a full face shield when needed.**
2. **Do not point the ejection port at anyone in the vicinity (especially his face). Keep hands and feet away from the ejection port area.**
3. **Always remove the battery cartridge before loading the staples, adjustment, inspection, maintenance or after operation is over.**

4. Make sure no one is nearby before operation. Never attempt to drive staples from both the inside and outside of wall at the same time. Staples may rip through and/or fly off, presenting a grave danger.
5. Watch your footing and maintain your balance with the tool. Make sure there is no one below when working in high locations.
6. Check walls, ceilings, floors, roofing and the like carefully to avoid possible electrical shock, gas leakage, explosions, etc. caused by stapling into live wires, conduits or gas pipes.
7. Use only staples specified in this manual. The use of any other staples may cause malfunction of the tool.
8. Do not tamper with the tool or attempt to use it for other than driving staples.
9. Do not operate the tool without staples. It shortens the service life of the tool.
10. Stop driving operations immediately if you notice something wrong or out of the ordinary with the tool.
11. Never staple into any materials which may allow the staple to puncture and fly through as a projectile.
12. Never actuate the switch trigger and safety lever at the same time until you are prepared to staple workpieces. Allow the workpiece to depress the safety lever. Never defeat its purpose by securing the safety lever back or by depressing it by hand.
13. Never tamper with the safety lever. Check the safety lever frequently for proper operations.
5. Do not short the battery cartridge:
 - (1) Do not touch the terminals with any conductive material.
 - (2) Avoid storing battery cartridge in a container with other metal objects such as nails, coins, etc.
 - (3) Do not expose battery cartridge to water or rain.
A battery short can cause a large current flow, overheating, possible burns and even a breakdown.
6. Do not store the tool and battery cartridge in locations where the temperature may reach or exceed 50 ° C (122 ° F).
7. Do not incinerate the battery cartridge even if it is severely damaged or is completely worn out. The battery cartridge can explode in a fire.
8. Be careful not to drop or strike battery.
9. Do not use dropped or struck battery.

SAVE THESE INSTRUCTIONS.

Tips for maintaining maximum battery life

1. Charge the battery cartridge before completely discharged. Always stop tool operation and charge the battery cartridge when you notice less tool power.
2. Never recharge a fully charged battery cartridge. Overcharging shortens the battery service life.
3. Charge the battery cartridge with room temperature at 10 ° C - 40 ° C (50 ° F - 104 ° F). Let a hot battery cartridge cool down before charging it.

SAVE THESE INSTRUCTIONS.

ENC007-4

IMPORTANT SAFETY INSTRUCTIONS FOR BATTERY CARTRIDGE

1. Before using battery cartridge, read all instructions and cautionary markings on (1) battery charger, (2) battery, and (3) product using battery.
2. Do not disassemble battery cartridge.
3. If operating time has become excessively shorter, stop operating immediately. It may result in a risk of overheating, possible burns and even an explosion.
4. If electrolyte gets into your eyes, rinse them out with clear water and seek medical attention right away. It may result in loss of your eyesight.

FUNCTIONAL DESCRIPTION

⚠CAUTION:

- Always be sure that the tool is switched off and the battery cartridge is removed before adjusting or checking function on the tool.

Installing or removing battery cartridge

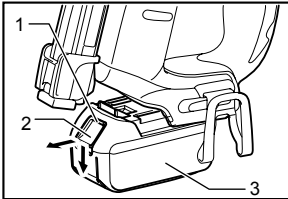

1. Red part
2. Button
3. Battery cartridge

014790

- Always switch off the tool before insertion or removal of the battery cartridge.
- To remove the battery cartridge, withdraw it from the tool while sliding the button on the front of the cartridge.
- To insert the battery cartridge, align the tongue on the battery cartridge with the groove in the housing and slip it into place. Always insert it all the way until it locks in place with a little click. If you can see the red part on the upper side of the button, it is not locked completely. Insert it fully until the red part cannot be seen. If not, it may accidentally fall out of the tool, causing injury to you or someone around you.
- Do not use force when inserting the battery cartridge. If the cartridge does not slide in easily, it is not being inserted correctly.

Safety system

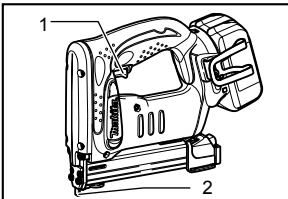

1. Trigger
2. Safety lever

014791

Make sure all safety systems are in working order before operation. The tool must not operate if only the switch trigger is pulled or if only the safety lever is pressed against the wood. It must work only when both actions are performed. Test for possible faulty operation with a tool unloaded and pointed well away from yourself or any bystanders.

NOTE:

- There is a possibility that the tool may operate for an instant when only the trigger is pulled. This does not indicate a problem. If this occurs, point the tool well away from yourself or any bystanders. Release and pull the trigger again to make sure the safety systems are in working order.

ASSEMBLY

⚠CAUTION:

- Always make sure that your fingers are not placed on the trigger and the battery cartridge is removed before carrying out any work on the stapler.

Staples

- Handle the staples and their box carefully. If the staples have been handled roughly, they may be bent out of shape, causing poor staple feed or jamming.
- Avoid storing the staples in a very humid or hot place or place exposed to direct sunlight.

⚠CAUTION:

- Do not use staples other than designated in this manual or staples that appear to be damaged, bent, rusty or corroded.
- Do not insert staples of which size is different each other at the same time inside the magazine, causing poor staple feed or jamming.

Loading staples

Remove the battery cartridge.

Press the locking lever on the rear of the sub magazine and slide the sub magazine backward.

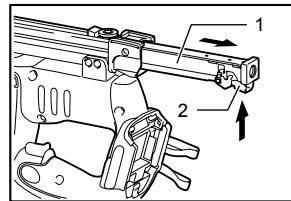

1. Sub magazine
2. Locking lever

014792

Load staples into the main magazine with their feet facing up. Slide the sub-magazine forward.

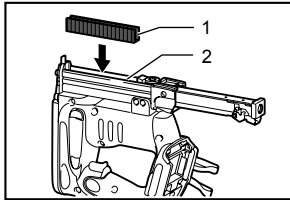

1. Staples
2. Main magazine

014793

To secure the sub magazine in place, hook the locking lever on the rear of the sub-magazine.

⚠CAUTION:

- With the magazine loaded, if the tool is held downward and the sub-magazine is opened, the staples can fall out and present a danger to anyone or anything below. Keep this in mind especially when working in high locations.

Unloading staples

⚠CAUTION:

- When removing staples, make sure that your fingers are not placed on the trigger or the lever and the battery cartridge is removed from the stapler. Misfiring may cause personal injuries and property damage.

Remove the battery cartridge.

Press the locking lever and slide the magazine back.

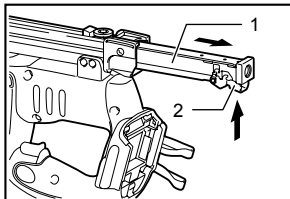

1. Sub magazine
2. Locking lever

014792

Take out staples from the magazine slit.

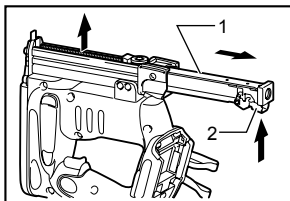

1. Sub magazine
2. Locking lever

014798

Hook

⚠CAUTION:

- Always make sure that your fingers are not placed on the trigger or the lever and the battery cartridge is removed before using the hook.

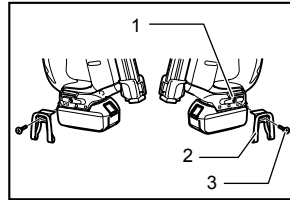

1. Groove
2. Hook
3. Screw

014795

⚠CAUTION:

- Do not hang the hook from the waist belt. Dropping the stapler, which is caused by the hook accidentally coming out of place, may cause misfiring and personal injuries.

The hook is convenient for temporarily hanging the tool. This can be installed on either side of the tool.

To install the hook, insert it into a groove in the tool housing on either side and then secure it with a screw. To remove, loosen the screw and then take it out.

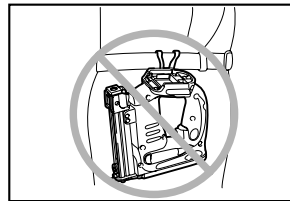

014794

OPERATION

Depth adjustment

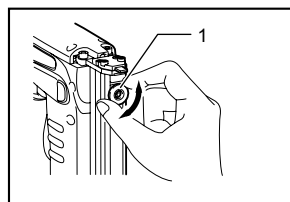

1. Nut

009163

If the staples are driven too deep or too shallow, adjust the driving depth by turning the nut on the bottom of the tool. For deeper driving of staples, turn the nut clockwise. For shallower driving, turn the nut counterclockwise. Please note the nut must be turned in increments of 90° (1/4 turn) so that the groove on the nut runs parallel to the magazine.

Driving staples

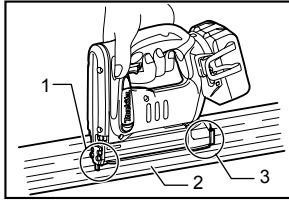

014796

Place flat the opening of the tool from which staples are fired on the material to be fastened and hold the tool firmly against the material. Then pull the lever and then pull the trigger fully to drive the staples. The grip is shaped so that the tool head can be held down securely with index finger and thumb. After driving a staple, be sure to release the trigger fully.

When the head of driven staple remains above the surface of material to be fastened, drive the staple while holding the stapler head firmly.

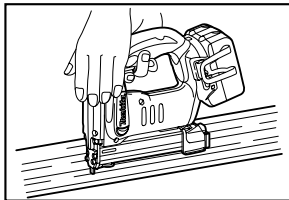

014797

NOTE:

- Using the stapler continuously with the head of driven staples remaining above the surface of material to be fastened may cause damage to the driver of the stapler and stapler jamming etc..

Checking remaining staples

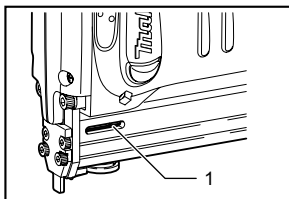

009161

CAUTION:

- Do not operate the tool without staples. It shortens the service life of the tool.

There is a convenient sight window on the right side of the tool (when viewing the tool from the front). Use this sight window to check if there are staples in the magazine. When staples are not visible through the window, load staples into the magazine.

Removing jammed staples

WARNING:

- Always make sure that the trigger are released and the battery cartridge is removed before removing jammed staples .

Remove the battery cartridge from the stapler.

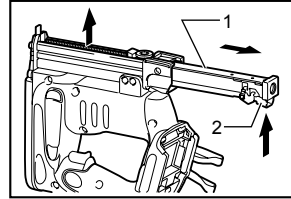

014798

Press the locking lever on the rear of the sub magazine and slide the sub magazine backward.

Take out stuck staples that remain inside the opening that staples are fired from as it appears.

MAINTENANCE

CAUTION:

- Always be sure that the tool is switched off and the battery cartridge is removed before attempting to perform inspection or maintenance.
- Never use gasoline, benzine, thinner, alcohol or the like. Discoloration, deformation or cracks may result.

To maintain product SAFETY and RELIABILITY, repairs, any other maintenance or adjustment should be performed by Makita Authorized Service Centers, always using Makita replacement parts.

OPTIONAL ACCESSORIES

CAUTION:

- These accessories or attachments are recommended for use with your Makita tool specified in this manual. The use of any other accessories or attachments might present a risk of injury to persons. Only use accessory or attachment for its stated purpose.

If you need any assistance for more details regarding these accessories, ask your local Makita Service Center.

- Staples
- Various type of Makita genuine batteries and chargers
- Safety goggles

NOTE:

- Some items in the list may be included in the tool package as standard accessories. They may differ from country to country.

Makita Corporation