

INSTRUCTION MANUAL

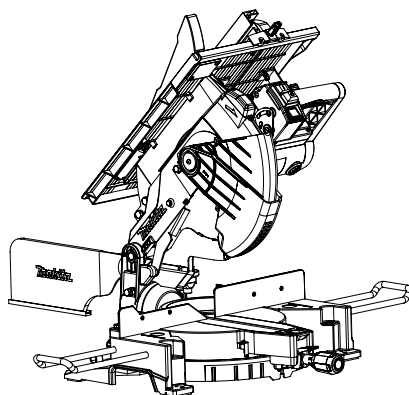

Table Top Miter Saw

LH1201FL



012174



DOUBLE INSULATION

IMPORTANT: Read Before Using.

ENGLISH (Original instructions)

SPECIFICATIONS

Model	LH1201FL
Blade diameter	305 mm
Hole diameter	
For all countries other than European countries	25.4 mm
For European countries	30 mm
Max. Cutting capacities (H x W) with blade 305 mm in diameter in the miter saw mode	

	Miter angle	
	90°	45° (left to right)
Bevel angle 90°	95 mm x 155 mm	95 mm x 110 mm
	62 mm x 200 mm	62 mm x 135 mm
Bevel angle 45°	64 mm x 155 mm	64 mm x 65 mm
	40 mm x 200 mm	40 mm x 85 mm

Max. Cutting capacities at 90° in the table saw (bench saw mode)	52 mm
No load speed (min ⁻¹)	3,800
Laser Type	Red Laser 650 nm, < 1 mW (Laser Class 2)
Table size (W x L)	307 mm x 465 mm
Dimensions (L x W x H)	610 mm x 535 mm x 692 mm
Net weight	20.9 kg
Safety class	□/II

- Due to our continuing program of research and development, the specifications herein are subject to change without notice.
- Specifications may differ from country to country.
- Weight according to EPTA-Procedure 01/2003

END292-4



Only for EU countries

Do not dispose of electric equipment together with household waste material! In observance of the European Directive, on Waste Electric and Electronic Equipment and its implementation in accordance with national law, electric equipment that have reached the end of their life must be collected separately and returned to an environmentally compatible recycling facility.

ENE060-1

Symbols

The following show the symbols used for the equipment. Be sure that you understand their meaning before use.



- Read instruction manual.



- DOUBLE INSULATION



- To avoid injury from flying debris, keep holding the saw head down, after making cuts, until the blade has come to a complete stop.



- When using the tool in the miter saw mode, secure the top table at the topmost position so that the saw blade never protrudes from the top surface of the top table.



- Do not place hand or fingers close to the blade.



- For your safety, remove the chips, small pieces, etc. from the table top before operation.



- Never look into the laser beam. Direct laser beam may injure your eyes.

Intended use

The tool is intended for accurate straight cutting and (only when used as a miter saw on the lower table) miter cutting in wood.

ENF002-1

Power supply

The tool should be connected only to a power supply of the same voltage as indicated on the nameplate, and can only be operated on single-phase AC supply. They are double-insulated in accordance with European Standard and can, therefore, also be used from sockets without earth wire.

SAFETY INSTRUCTIONS

WARNING! When using electric tools, basic safety precautions, including the following, should always be followed to reduce the risk of fire, electric shock and personal injury. Read all these instructions before operating this product and save these instructions.

For safe operations:

1. **Keep work area clean.**
Cluttered areas and benches invite injuries.
2. **Consider work area environment.**
Do not expose power tools to rain. Do not use power tools in damp or wet locations. Keep work area well lit. Do not use power tools where there is risk to cause fire or explosion.
3. **Guard against electric shock.**
Avoid body contact with earthed or grounded surfaces (e.g. pipes, radiators, ranges, refrigerators).
4. **Keep children away.**
Do not let visitors touch the tool or extension cord. All visitors should be kept away from work area.
5. **Store idle tools.**
When not in use, tools should be stored in a dry, high or locked up place, out of reach of children.
6. **Do not force the tool.**
It will do the job better and safer at the rate for which it was intended.
7. **Use the right tool.**
Do not force small tools or attachments to do the job of a heavy duty tool. Do not use tools for purposes not intended; for example, do not use circular saws to cut tree limbs or logs.
8. **Dress properly.**
Do not wear loose clothing or jewellery, they can be caught in moving parts. Rubber gloves and non-skid footwear are recommended when working outdoors. Wear protecting hair covering to contain long hair.
9. **Use safety glasses and hearing protection.**
Also use face or dust mask if the cutting operation is dusty.
10. **Connect dust extraction equipment.**
If devices are provided for the connection of dust extraction and collection facilities ensure these are connected and properly used.
11. **Do not abuse the cord.**
Never carry the tool by the cord or yank it to disconnect it from the socket. Keep the cord away from heat, oil and sharp edges.
12. **Secure work.**
Use clamps or a vice to hold the work. It is safer than using your hand and it frees both hands to operate the tool.
13. **Do not overreach.**
Keep proper footing and balance at all times.
14. **Maintain tools with care.**
Keep cutting tools sharp and clean for better and safer performance. Follow instructions for lubrication and changing accessories. Inspect tool cord periodically and if damaged have it repaired by an authorized service facility. Inspect extension cords periodically and replace, if damaged. Keep handles dry, clean and free from oil and grease.
15. **Disconnect tools.**
When not in use, before servicing and when changing accessories such as blades, bits and cutters.
16. **Remove adjusting keys and wrenches.**
Form the habit of checking to see that keys and adjusting wrenches are removed from the tool before turning it on.
17. **Avoid unintentional starting.**
Do not carry a plugged-in tool with a finger on the switch. Ensure switch is off when plugging in.
18. **Use outdoor extension leads.**
When tool is used outdoors, use only extension cords intended for outdoor use.
19. **Stay alert.**
Watch what you are doing. Use common sense. Do not operate tool when you are tired.
20. **Check damaged parts.**
Before further use of the tool, a guard or other part that is damaged should be carefully checked to determine that it will operate properly and perform its intended function. Check for alignment of moving parts, free running of moving parts, breakage of parts, mounting and any other conditions that may affect its operation. A guard or other part that is damaged should be properly repaired or replaced by an authorized service center unless otherwise indicated in this instruction manual. Have defective switches replaced by an authorized service facility. Do not use the tool if the switch does not turn it on and off.
21. **Warning.**
The use of any accessory or attachment, other than those recommended in this instruction manual or the catalog, may present a risk of personal injury.
22. **Have your tool repaired by a qualified person.**
This electric tool is in accordance with the relevant safety requirements. Repairs should only be carried out by qualified persons using original spare parts, otherwise this may result in considerable danger to the user.

ADDITIONAL SAFETY RULES FOR TOOL

FOR BOTH MITER SAW MODE AND TABLE SAW (BENCH SAW) MODE

1. Wear eye and hearing protection. Other suitable personal protective equipment should be worn.
2. NEVER wear gloves during operation except for replacing saw blades or handling rough material before operation.
3. Keep the floor area around the tool level well maintained and free of loose materials e.g. chips and cut-offs.
4. Do not operate saw without guards and riving knife in place. Check blade guards for proper closing before each use. Do not operate saw if blade guards do not move freely and close instantly. Never clamp or tie the blade guards into the open position. Any irregular operation of the blade guards should be corrected immediately.
5. Clean and be careful not to damage the spindle, flanges (especially the installing surface) and hex bolt before or when installing the blade. Damage to these parts could result in blade breakage. Poor installation may cause vibration/wobbling or slippage of the blade. Use only flanges specified for this tool.
6. Check the blade carefully for cracks or damage before operation. Do not use saw blade which are damaged or deformed.
7. Use only saw blades recommended by the manufacturer and which conform to EN847-1, and observe that the riving knife must not be thicker than the width of the cut by the saw blade and not thinner than the body of the blade.
8. Always use accessories recommended in this manual. Use of improper accessories such as abrasive cut-off wheels may cause an injury.
9. Select the correct saw blade for the material to be cut.
10. Do not use saw blades manufactured from high speed steel.
11. To reduce the emitted noise, always be sure that the blade is sharp and clean.
12. Use correctly sharpened saw blades. Observe the maximum speed marked on the saw blade.
13. Do not cut metal objects such as nails and screws. Inspect for and remove all nails, screws and other foreign material from the workpiece before operation.
14. Knock out any loose knots from workpiece BEFORE beginning to cut.
15. Do not use the tool in the presence of flammable liquids or gases.
16. For your safety, remove the chips, small pieces, etc. from the work area and table top before plugging the tool and starting operation.
17. The operator is adequately trained in the use, adjustment and operation of the tool.
18. Keep hands and make your bystander and yourself position out of path of and not in line with saw blade. Avoid contact with any coating blade. It can still cause severe injury and never reach around saw blade.
19. Be alert at all times, especially during repetitive, monotonous operations. Do not be lulled into a false sense of security. Blades are extremely unforgiving.
20. Make sure the shaft lock is released before the switch is turned on.
21. Before using the tool on an actual workpiece, let it run for a while. Watch for vibration or wobbling that could indicate poor installation or a poorly balanced blade.
22. Wait until the blade attains full speed before cutting.
23. The tool should not be used for slotting, rabbetting or grooving.
24. Refrain from removing any cut-offs or other parts of the workpiece from the cutting area whilst the tool is running and the saw head is not in the rest position.
25. Stop operation immediately if you notice anything abnormal.
26. Turn off tool and wait for saw blade to stop before moving workpiece or changing settings.
27. Unplug tool before changing blade, servicing or not in use.
28. Some dust created from operation contains chemicals known to cause cancer, birth defects or other reproductive harm. Some examples of these chemicals are:
 - lead from lead-based-painted material and,
 - arsenic and chromium from chemically-treated lumber.

Your risk from these exposures varies, depending on how often you do this type of work. To reduce your exposure to these chemicals: work in a well ventilated area and work with approved safety equipment, such as those dust masks that are specially designed to filter out microscopic particles.
29. Connect the tool to a dust collecting device when sawing.

30. When fitted with laser, no exchange with different type of laser is permitted. Repairs shall only be carried out correctly.
31. Even when the tool is used as prescribed it is not possible to eliminate all residual risk factors. The following hazards may arise in connection with the tool's construction and design:
 - Damage to health resulting from hand-arm vibrations if the power tool is used over a longer period of time and is not operated or serviced correctly.
 - Injury or damage caused by loose tool attachments which can unexpectedly slide out/from the power tool due to sudden damage, wear or improper mounting.

WHEN USING IN MITER SAW MODE:

32. Do not use the saw to cut other than wood, aluminum or similar materials.
33. Do not perform operation freehand when cutting workpiece in an area close to saw blade. The workpiece must be secured firmly against the turn base and guide fence during all operations.
34. Make sure that the turn base is properly secured so it will not move during operation.
35. Make sure that the arm is securely fixed when beveling. Tighten the lever clockwise to fix the arm.
36. Make sure the blade does not contact the turn base in the lowest position and is not contacting the workpiece before the switch is turned on.
37. Hold the handle firmly. Be aware that the saw moves up or down slightly during start-up and stopping.
38. Replace the kerf board when worn.

WHEN USING IN THE TABLE SAW (BENCH SAW) MODE:

39. Do not perform any operation freehand. Freehand means using your hands to support or guide the workpiece, in lieu of a rip fence.
40. Make sure that the arm is securely fixed in the working position. Tighten the lever clockwise to fix the arm.
41. Use a push stick or a push block to avoid working with the hands and fingers close to the saw blade.
42. Make sure that the bench saw table is securely fixed at the chosen height.

43. Make sure the blade is not contacting the riving knife or workpiece before the switch is turned on.
44. Always store the push-stick when it is not in use.
45. Pay particular attention to instructions for reducing risk of KICKBACK. KICKBACK is a sudden reaction to a pinched, bound or misaligned saw blade. KICKBACK causes the ejection of the workpiece from the tool back towards the operator. KICKBACKS CAN LEAD TO SERIOUS PERSONAL INJURY. Avoid KICKBACKS by keeping the blade sharp, by keeping the rip fence parallel to the blade, by keeping the riving knife and blade guard in place and operating properly, by not releasing the workpiece until you have pushed it all the way past the blade, and by not ripping a workpiece that is twisted or warped or does not have a straight edge to guide along the fence.
46. Avoid abrupt, fast feeding. Feed as slowly as possible when cutting hard workpieces. Do not bend or twist workpiece while feeding. If you stall or jam the blade in the workpiece, turn the tool off immediately. Unplug the tool. Then clear the jam.

SAVE THESE INSTRUCTIONS.

INSTALLATION

⚠CAUTION:

Keep the floor area around the tool level well maintained and free of loose materials such as chips and cut-offs.

Bench mounting

This tool should be bolted with two bolts to a level and stable surface using the bolt holes provided in the tool's base. This will help prevent tipping and possible injury.

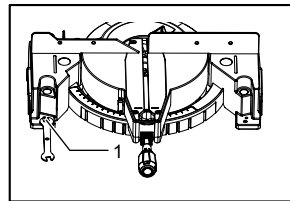

1. Bolt

012175

FUNCTIONAL DESCRIPTION

⚠CAUTION:

- Always be sure that the tool is switched off and unplugged before adjusting or checking function on the tool.

Blade guard

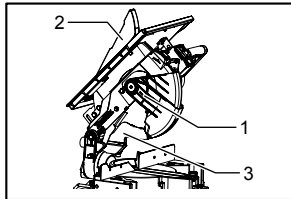

012176

- Lower blade guard A
- Top blade guard
- Lower blade guard B

⚠CAUTION:

- Make sure that the handle cannot be lowered without pushing the lever nearby the handle to the left.
- Make sure that the lower blade guards A and B do not open unless the lever near the handle is pushed at the topmost position of the handle.

When lowering the handle while pushing the lever to the left, the lower blade guard A rises automatically. The lower blade guards are spring loaded so it returns to its original position when the cut is completed and the handle is raised. The top blade guard falls flat on the top surface after workpiece has passed under it. NEVER DEFEAT OR REMOVE THE LOWER BLADE GUARDS, THE SPRING WHICH ATTACHES TO THE LOWER BLADE GUARD, OR THE TOP BLADE GUARD.

In the interest of your personal safety, always maintain each blade guard in good condition. Any irregular operation of the guards should be corrected immediately. Check to assure spring loaded return action of the lower blade guards. NEVER USE THE TOOL IF THE LOWER BLADE GUARD, SPRING OR THE TOP BLADE GUARD ARE DAMAGED, FAULTY OR REMOVED. DOING SO IS HIGHLY DANGEROUS AND CAN CAUSE SERIOUS PERSONAL INJURY.

If any of these see-through blade guards becomes dirty, or sawdust adheres to it in such a way that the blade is no longer easily visible, unplug the saw and clean the guards carefully with a damp cloth. Do not use solvents or any petroleum-based cleaners on the plastic guard.

If the lower blade guard A is especially dirty and vision through the guard is impaired, proceed as follows. Fix the top table at the fully elevated position, raise the handle fully, push in fully the stopper pin with the handle fully raised, and use the supplied socket wrench to loosen the hex bolt holding the center cover. Loosen the hex bolt by turning it counterclockwise and raise the lower blade

guard A and center cover while pushing the lever to the left. With the lower blade guard A so positioned, cleaning can be more completely and efficiently accomplished. When cleaning is complete, reverse procedure above and secure bolt.

In the same case for the top blade guard as above stated, loosen the screw holding it with a screwdriver and remove the top blade guard. After cleaning, always reinstall it securely by tightening the screw to the extent that the top blade guard moves smoothly up or down.

If any of these blade guards becomes discolored through age or UV light exposure, contact a Makita service center for a new guard. DO NOT DEFEAT OR REMOVE GUARDS.

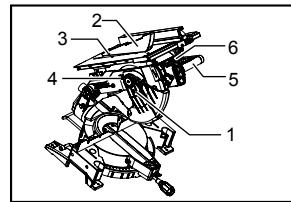

012177

- Lower blade guard A
- Top blade guard
- Screw
- Hex bolt
- Handle
- Lever

Maintaining maximum cutting capacity

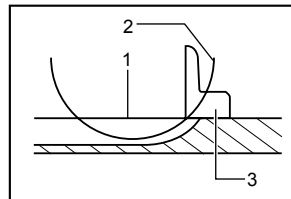

012178

- Top surface of turn base
- Periphery of blade
- Guide fence

This tool is factory adjusted to provide the maximum cutting capacity for a 305 mm saw blade.

⚠CAUTION:

- After installing a new blade, always be sure that the blade does not contact any part of the lower base when the handle is lowered completely. Always do this with the tool unplugged.

Adjusting the miter angle

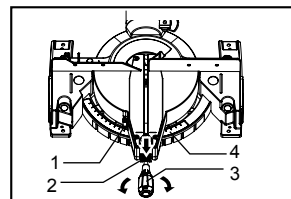

012179

- Pointer
- Lock lever
- Grip
- Miter scale

Loosen the grip by turning counterclockwise. Turn the turn base while pressing down the lock lever. When you have moved the grip to the position where the pointer points to the desired angle on the miter scale, securely tighten the grip clockwise.

⚠CAUTION:

- When turning the turn base, be sure to raise the handle fully.
- After changing the miter angle, always secure the turn base by tightening the grip firmly.

Adjusting the bevel angle

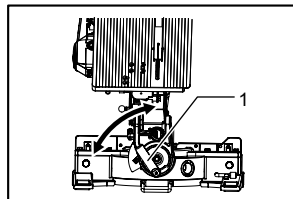

1. Lever

012180

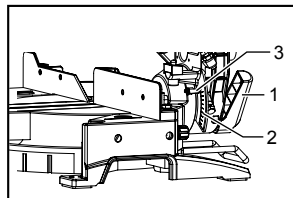

1. Lever
2. Bevel scale
3. Pointer

012181

To adjust the bevel angle, loosen the lever at the rear of the tool counterclockwise.

Push the handle to the left to tilt the saw blade until the pointer points to the desired angle on the bevel scale. Then tighten the lever clockwise firmly to secure the arm.

⚠CAUTION:

- When tilting the saw blade, be sure to raise the handle fully.
- After changing the bevel angle, always secure the arm by tightening the lever clockwise.

Switch action

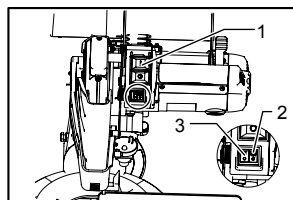

1. Power Switch
2. Lamp switch
3. Laser switch

012182

⚠CAUTION:

- Before operation, make sure that the tool is turned on and off.

To start the tool, press the ON (I) button. To stop it, press the OFF (O) button.

Lighting up the lamps

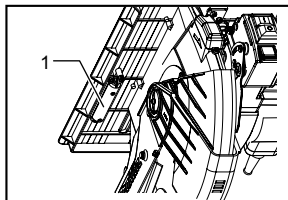

1. Lamp

012183

Push the upper position of the switch for turning on the light and the lower position for off.

⚠CAUTION:

- Do not look in the light or see the source of light directly.

NOTE:

- Use a dry cloth to wipe the dirt off the lens of lamp. Be careful not to scratch the lens of lamp, or it may lower the illumination.

Laser beam action

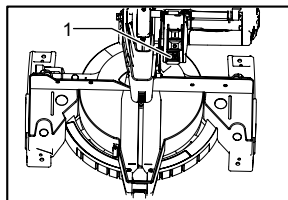

1. Switch for laser

012184

⚠CAUTION:

- **LASER RADIATION**
Do not stare into beam.

To turn on the laser beam, press the upper position (I) of the switch. To turn off the laser beam, press the lower position (O) of the switch.

Adjusting the up and down of top table

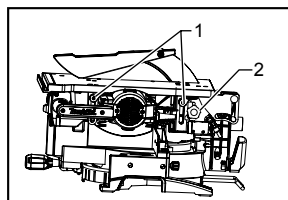

1. Lever
2. Knob

015680

To adjust the up and down of top table, loosen two levers by turning counterclockwise and then turn the knob. To raise the top table, turn the knob clockwise. To lower the top table, turn the knob counterclockwise. Tighten these levers firmly after the adjustment.

⚠WARNING:

- Position the top table at the topmost position when using the tool in the miter saw mode and at the desired position when using in the table saw mode (bench mode).

ASSEMBLY

⚠CAUTION:

- Always be sure that the tool is switched off and unplugged before carrying out any work on the tool.

Installing or removing saw blade

⚠CAUTION:

- Always be sure that the tool is switched off and unplugged before installing or removing the blade.
- Use only the Makita socket wrench provided to install or remove the blade. Failure to do so may result in overtightening or insufficient tightening of the hex bolt. This could cause an injury.

Secure the top table at the topmost position.

Lock the handle in the raised position by pushing in the stopper pin.

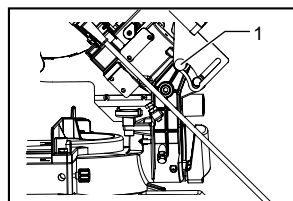

012188

1. Stopper pin

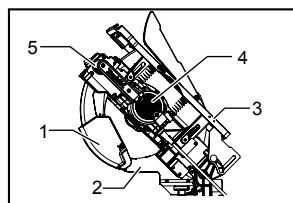

012189

1. Lower blade guard A
2. Lower blade guard B
3. Top table
4. Motor housing
5. Handle

Then use the socket wrench to loosen the hex bolt holding the center cover by turning it counterclockwise. Raise the lower blade guard A and center cover while pushing the lever nearby the handle to the left.

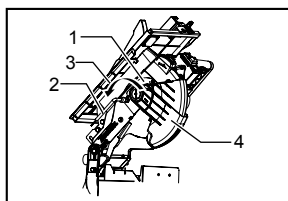

012190

1. Center cover
2. Socket wrench
3. Hex bolt
4. Lower blade guard A

Press the shaft lock to lock the spindle, use the socket wrench to loosen the hex bolt clockwise. Then remove the hex bolt, outer flange and blade.

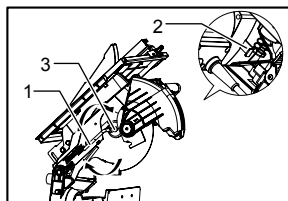

012191

1. Socket wrench
2. Shaft lock
3. Hex bolt

To install the blade, mount it carefully onto the spindle, making sure that the direction of the arrow on the surface of the blade matches the direction of the arrow on the blade case. Install the outer flange and hex bolt, and then use the socket wrench to tighten the hex bolt (left-handed) securely counterclockwise while pressing the shaft lock.

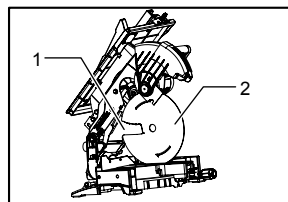

012192

1. Blade guard B
2. Saw blade

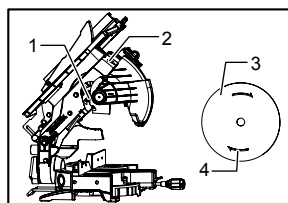

012193

1. Blade case
2. Arrow
3. Saw blade
4. Arrow

For all countries other than European countries

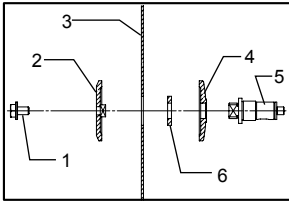

1. Hex bolt
2. Outer flange
3. Saw blade
4. Inner flange
5. Spindle
6. Ring

012194

⚠ CAUTION:

- The ring 25.4 mm in outer diameter is factory-installed onto the spindle. Before mounting the blade onto the spindle, always be sure that the correct ring for the arbor hole of the blade you intend to use is installed onto the spindle.

For European countries

⚠ CAUTION:

- The ring 30 mm in outer diameter is factory-installed between the inner and outer flanges.

Return the lower blade guard A and center cover to its original position. Then tighten the hex bolt clockwise to secure the center cover. Raise the blade guard B as far as it will go and tighten the clamping screw firmly while holding it in the raised position. Lower the handle to make sure that the lower blade guards move properly. Make sure shaft lock has released spindle before making cut.

Adjusting riving knife

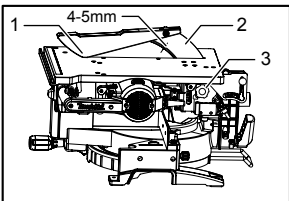

1. Top blade guard
2. Riving knife
3. Knob

015681

Before adjusting the riving knife, loosen the two levers by turning counterclockwise and move the top table to its lowered position by turning the knob counterclockwise. Then secure the top table by firmly re-tightening the two levers as shown in the figure.

There must be a clearance of about 4 - 5 mm between the riving knife and the blade teeth. Adjust the riving knife accordingly by loosening two hex bolts counterclockwise with the hex socket wrench and measuring the distance. Tighten the hex bolts securely, and then check to see that the top blade guard works smoothly before cutting.

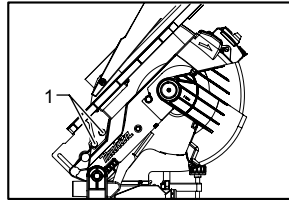

012196

The riving knife has been installed before shipment from the factory so that the blade and riving knife are in a straight line.

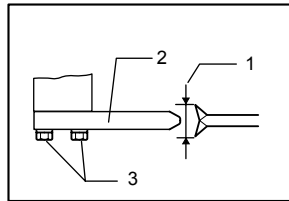

012197

⚠ CAUTION:

- If the blade and riving knife are not aligned properly, a dangerous pinching condition may result during operation. Make sure the riving knife is positioned between both outer ends of the blade teeth when viewing from the top. You could suffer serious personal injury while using the tool without a properly aligned riving knife. If they are not aligned for any reasons, always have Makita authorized service center repair it.
- Don't remove the riving knife.

Installing and adjusting rip fence

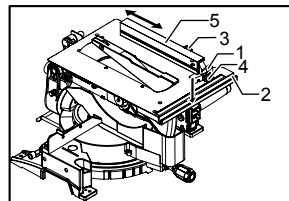

012198

1. Install the rip fence on the table so that the rip fence holder engages with the guide rail. Tighten the clamping screw (B) of the rip fence firmly clockwise.
2. Loosen the clamping screw (A).
3. Slide the rip fence and secure it so that the far end from you of the rip fence is aligned with the point at which the front edge of saw blade just appears from top surface of the workpiece. The purpose of this adjustment is to reduce risk of kick-back toward operator that cut piece from the workpiece

is pinched between the saw blade and rip fence and finally pushed out toward operator. The line 3 varies by thickness of workpiece or the table level. Adjust the position of the rip fence according to the thickness of the workpiece.

After adjusting the rip fence, tighten the clamping screw (A) firmly.

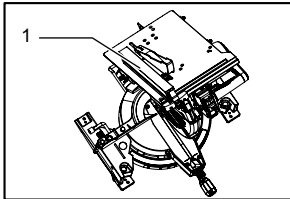

1. Rip fence

012199

NOTE:

- The rip fence must be mounted the left side of the saw blade when in the miter saw mode.

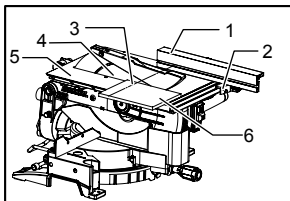

1. Rip fence
2. Rip fence holder
3. Line to be aligned with
4. Saw blade
5. Top table
6. Workpiece

012200

NOTE:

- There are four patterns to position the rip fence as shown in the figure. Rip fence has two slits on its sides, one slit with an elevated fringe nearby on the same side and the other without it. Use the surface of rip fence with this fringe facing the workpiece only when cutting off into a piece of a thin workpiece.

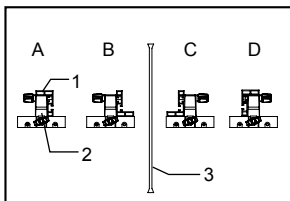

1. Rip fence
2. Rip fence holder
3. Saw blade

012201

NOTE:

- To change the rip fence pattern, remove the rip fence from the rip fence holder by loosening the clamping screw (A) and change the facing of the rip fence to the rip fence holder so that the rip fence faces the rip fence holder according to your work as shown in the figure.

Insert the square nut on the rip fence holder into the back end of either slit of the rip fence so that they fit as shown in the figure.

To change from the pattern A or B to the pattern C or D, or in adverse case, remove the square nut, washer and clamping screw (A) from the rip fence holder, then position the clamping screw (A), washer and square nut on the opposite position of the rip fence holder compared to the original position. Tighten the clamping screw (A) securely after inserting the square nut of the rip fence holder into the rip fence slit.

Insert the square nut on the rip fence holder into the back end of either slit of the rip fence so that they fit as shown in the figure.

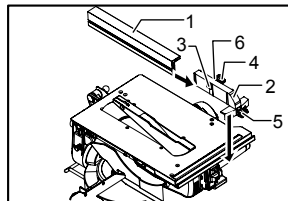

1. Rip fence
2. Rip fence holder
3. Square nut
4. Clamp screw (A)
5. Clamp screw (B)
6. Washer

012202

The rip fence is factory adjusted so that it is parallel to the blade surface. Make sure that it is parallel. To check to be sure that the rip fence is parallel with the blade. Lower the table to the lowest position so that the blade appears at the topmost position from the table. Mark one of the blade teeth with a crayon. Measure the distance (A) and (B) between the rip fence and blade. Take both measurements using the tooth marked with the crayon. These two measurements should be identical. If the rip fence is not parallel with the blade, proceed as follows:

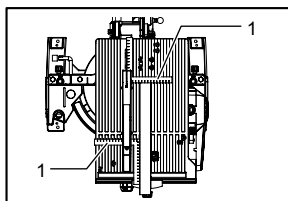

1. Scale

012203

- (1) Turn the adjusting screws counterclockwise.

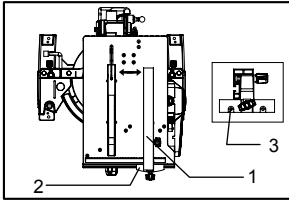

1. Rip fence
2. Rip fence holder
3. Adjusting screw

012204

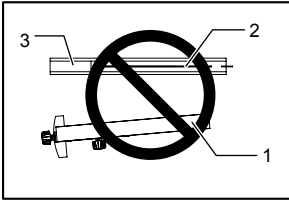

1. Rip fence
2. Saw blade
3. Top blade guard

012205

- (2) Shift the back edge of the rip fence slightly to right or left until it becomes parallel with the blade.
- (3) Tighten the adjusting screw on the rip fence firmly.

⚠ CAUTION:

- Be sure to adjust the rip fence so that it is parallel with the blade, or a dangerous kickback condition may occur.
- Be sure to adjust the rip fence so that it does not contact the top blade guard or saw blade.

Dust bag

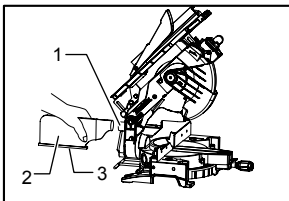

1. Dust nozzle
2. Dust bag
3. Fastener

012206

The use of the dust bag makes cutting operations clean and dust collection easy. To attach the dust bag, fit it onto the dust nozzle.

NOTE:

- In miter saw mode, always insert the dust bag to the back nozzle only.

When the dust bag is about half full, remove the dust bag from the tool and pull the fastener out. Empty the dust bag of its contents, tapping it lightly so as to remove particles adhering to the insides which might hamper further collection.

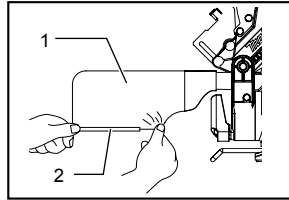

1. Dust bag
2. Fastener

012207

If you connect a vacuum cleaner to your saw, more efficient and cleaner operations can be performed.

When using in the table saw mode, connect a vacuum cleaner.

Table saw mode

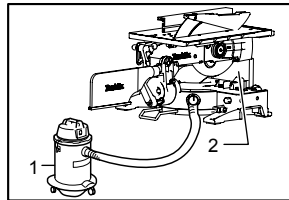

1. Vacuum cleaner
2. Blade cover

012208

Miter saw mode

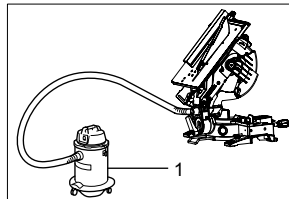

1. Vacuum cleaner

012209

To install the blade cover when using in the table saw mode (bench mode), turn the turn base to 0° miter angle (see the section titled "Adjusting miter angle") and place the blade cover on the turn table so that the blade cover is centered over the slit for the blade entrance in the turn table and then lock the handle in the lowest position by fully pushing in the stopper pin as shown in the figure.

NOTE:

- When using the tool in the table saw mode (bench mode), make sure that the blade cover is installed on the turn table.

Securing workpiece

Whenever possible, secure the workpiece with the optional vise. If you must use your hand to hold the workpiece, then it must be done firmly and securely so as not to lose control of the workpiece. Your hand and arm must be kept well away from the blade area (100mm minimum). Squeeze the workpiece firmly against the guide fence with your fingers held over the top of

the guide fence. The workpiece must also rest steadily on the turn base.

⚠WARNING:

- Never use your hand to hold the workpiece that requires your hand to be any closer than 100mm from the blade area. In this case, always use the optional vise to secure the workpiece. After any cutting operation, raise the blade gently. Never raise the blade until it has come to a complete stop. Serious injury may result.

⚠CAUTION:

- When cutting long workpieces, use supports that are as high as the top surface level of the turn base. Do not rely solely on the vertical vise and/or horizontal vise (optional) to secure the workpiece. Thin material tends to sag. Support workpiece over its entire length to avoid blade pinch and possible KICKBACK.

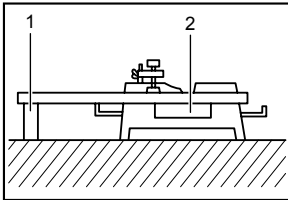

001549

1. Support
2. Turn base

Vertical vise

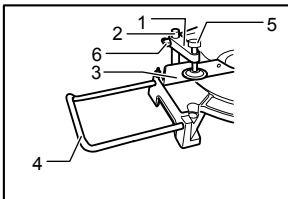

012228

1. Vise arm
2. Vise rod
3. Guide fence
4. Holder
5. Vise knob
6. Screw

The vertical vise can be installed in two positions on either the left or right side of the guide fence. Insert the vise rod into the hole in the guide fence or the holder assembly and tighten the screw to secure the vise rod. Position the vise arm according to the thickness and shape of the workpiece and secure the vise arm by tightening the screw. If the screw to secure the vise arm contacts the guide fence, install the screw on the opposite side of vise arm. Make sure that no part of the tool contacts the vise when lowering the handle all the way. If some part contacts the vise, re-position the vise. Press the workpiece flat against the guide fence and the turn base. Position the workpiece at the desired cutting position and secure it firmly by tightening the vise knob.

⚠CAUTION:

- The workpiece must be secured firmly against the turn base and guide fence.

Horizontal vise (optional accessory)

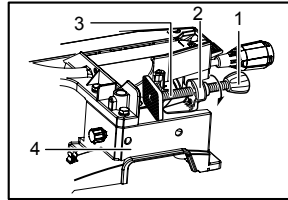

012210

1. Vise knob
2. Projection
3. Vise shaft
4. Base

The horizontal vise can be installed on either the left or right side of the base. When performing 30° or greater miter cuts, install the horizontal vise on the side opposite the direction in which the turn base is to be turned. By turning the vise knob counterclockwise, the screw is released and the vise shaft can be moved rapidly in and out. By turning the vise knob clockwise, the screw remains secured. To grip the workpiece, turn the vise knob gently clockwise until the projection reaches its topmost position, then fasten securely. If the vise knob is forced in or pulled out while being turned clockwise, the projection may stop at an angle. In this case, turn the vise knob back counterclockwise until the screw is released, before turning again gently clockwise.

The maximum width of the workpiece which can be secured by the horizontal vise is 200 mm.

OPERATION

⚠WARNING:

- When using the tool in the miter saw mode, secure the top table at the topmost position so that the saw blade never protrudes from the top surface of the top table.

⚠CAUTION:

- Before use, be sure to release the handle from the lowered position by pulling the stopper pin.
- Make sure the blade is not contacting the workpiece, etc. before the switch is turned on.

CUTTING AS MITER SAW

⚠CAUTION:

- Do not apply excessive pressure on the handle when cutting. Too much force may result in overload of the motor and/or decreased cutting efficiency. Push down handle with only as much force as is necessary for smooth cutting and without significant decrease in blade speed.
- Gently press down the handle to perform the cut. If the handle is pressed down with force or if lateral force is applied, the blade will vibrate and leave a mark (saw mark) in the workpiece and the precision

of the cut will be impaired.

1. Press cutting

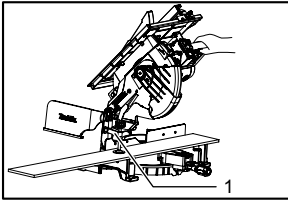

012211

Secure the workpiece against guide fence and turn table. Switch on the tool without the blade making any contact and wait until the blade attains full speed before lowering. Then gently lower the handle to the fully lowered position to cut the workpiece. When the cut is completed, switch off the tool and WAIT UNTIL THE BLADE HAS COME TO A COMPLETE STOP before returning the blade to its fully elevated position.

2. Miter cutting

Refer to the previously covered "Adjusting the miter angle".

3. Bevel cut

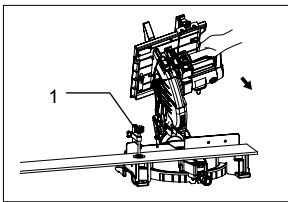

012212

Loosen the lever and tilt the saw blade to set the bevel angle (Refer to the previously covered "Adjusting the bevel angle"). Be sure to retighten the lever firmly to secure the selected bevel angle safely. Secure the workpiece against guide fence and turn table. Switch on the tool without the blade making any contact and wait until the blade attains full speed. Then gently lower the handle to the fully lowered position while applying pressure in parallel with the blade. When the cut is completed, switch off the tool and WAIT UNTIL THE BLADE HAS COME TO A COMPLETE STOP before returning the blade to its fully elevated position.

⚠CAUTION:

- Always be sure that the blade will move down to bevel direction during a bevel cut. Keep hands out of path of saw blade.

1. Vise

- During a bevel cut, it may create a condition whereby the piece cut off will come to rest against the side of the blade. If the blade is raised while the blade is still rotating, this piece may be caught by the blade, causing fragments to be scattered which is dangerous. The blade should be raised ONLY after the blade has come to a complete stop.
- When pressing the handle down, apply pressure parallel to the blade. If the pressure is not parallel to the blade during a cut, the angle of the blade might be shifted and the precision of the cut will be impaired.

4. Compound cutting

Compound cutting is the process in which a bevel angle is made at the same time in which a miter angle is being cut on a workpiece. Compound cutting can be performed at angle shown in the table.

Bevel angle	Miter angle
45°	Left and Right 0° - 45°

006366

When performing compound cutting, refer to "Press cutting", "Miter cutting" and "Bevel cut" explanations.

5. Cutting aluminum extrusion

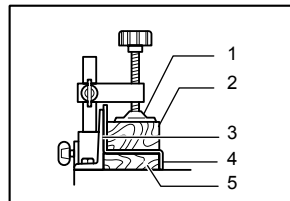

001844

- Vise
- Spacer block
- Guide fence
- Aluminum extrusion
- Spacer block

When securing aluminum extrusions, use spacer blocks or pieces of scrap as shown in the figure to prevent deformation of the aluminum. Use a cutting lubricant when cutting the aluminum extrusion to prevent build-up of the aluminum material on the blade.

⚠CAUTION:

- Never attempt to cut thick or round aluminum extrusions. Thick aluminum extrusions may come loose during operation and round aluminum extrusions cannot be secured firmly with this tool.
- Never cut aluminum in the table saw mode (bench mode).

6. Wood facing

Use of wood facing helps to assure splinter-free cuts in workpieces. Attach a wood facing to the guide fence using the holes in the guide fence. See the figure concerning the dimensions for a suggested wood facing.

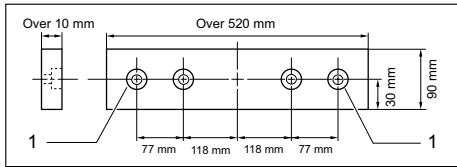

1. Hole
012270

CAUTION:

- Use straight wood of even thickness as the wood facing.
- Use screws to attach the wood facing to the guide fence. The screws should be installed so that the screw heads are below the surface of the wood facing.
- When the wood facing is attached, do not turn the turn base with the handle lowered. The blade and/or the wood facing will be damaged.

CUTTING AS TABLE SAW (BENCH MODE)

CAUTION:

- When using the tool in the table saw mode (bench mode), place the blade cover on the turn table so that the blade cover is centered over the slit for the blade entrance in the turn table and two small bosses on the underside of the blade cover fit into the semi-circular slit in the periphery of the guide fence on the turn table as shown in the figure and then lock the handle in the lowest position by fully pushing in the stopper pin. If not fixing the blade cover, the table can not be down.

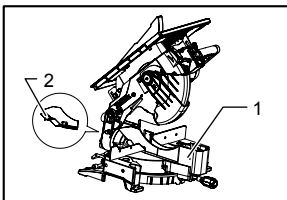

1. Blade cover
2. Small boss

012213

CAUTION:

- Always use "work helpers" such as push sticks and push blocks when there is a danger that your hands or fingers will come close to the blade.
- Always hold the workpiece firmly with the table and the rip fence. Do not bend or twist it while feeding. If the workpiece is bent or twisted, dangerous kickbacks may occur.
- NEVER withdraw the workpiece while the blade is running. If you must withdraw the workpiece before completing a cut, first switch the tool off while holding the workpiece firmly. Wait until the blade has come to a complete stop before withdrawing the workpiece. Failure to do so may cause dangerous kickbacks.

- NEVER remove cut-off material while the blade is running.
- NEVER place your hands or fingers in the path of the saw blade.
- Always secure the rip fence firmly, or dangerous kickbacks may occur.
- Always use "work helpers" such as push sticks and push blocks when cutting small or narrow workpieces.

Work helpers

Push sticks, push blocks or auxiliary fence are types of "work helpers". Use them to make safe, sure cuts without the need for the operator to contact the blade with any part of the body.

Push block

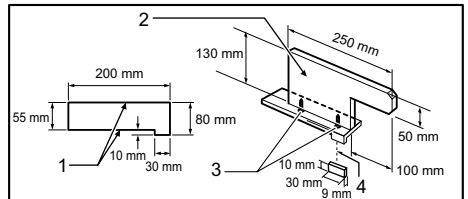

1. Face/edge parallel
2. Handle
3. Wood screw
4. Glue together

005566

Use a 15 mm piece of plywood.

Handle should be in center of plywood piece. Fasten with glue and wood screws as shown. Small piece 10 mm x 9 mm x 30 mm of wood must always be glued to plywood to keep the blade from dulling if the operator cuts into push block by mistake. (Never use nails in push block.)

Auxiliary fence

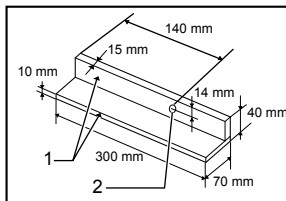

1. Face/edge parallel
2. Hole(7mm in diameter)

005565

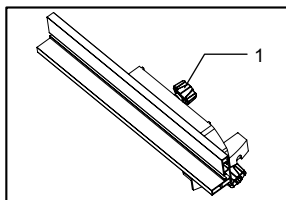

1. Clamping screw

012214

Make auxiliary fence from 10 mm and 15 mm plywood pieces.

Remove the rip fence, clamping screw (A), flat washer and square nut from the rip fence holder and then attach and secure the auxiliary fence to the rip fence holder by using a bolt M6 longer than M6x50, washers and nut.

Ripping

⚠CAUTION:

- When cutting long or large workpieces, always provide adequate support behind the table. DO NOT allow a long board to move or shift on the table. This will cause the blade to bind and increase the possibility of kickback and personal injury. The support should be at the same height as the table.
1. Adjust the depth of cut a bit higher than the thickness of the workpiece. To make this adjustment, loosen two levers and lower or raise the top table.
 2. Position the rip fence to the desired width of rip and secure in place by tightening the clamping screw (A). Before ripping, make sure the two screws of the rip fence holder are secured. If it is not secured enough, retighten it.
 3. Turn the tool on and gently feed the workpiece into the blade along with the rip fence.
 - (1) When the width of rip is 40 mm or wider, use a push stick.

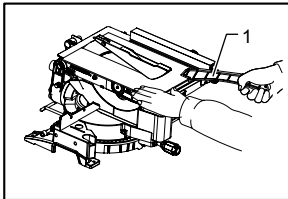

012215

1. Push stick

- (2) When the width of rip is narrower than 40 mm, the push stick cannot be used because the push stick will strike the top blade guard. Use the auxiliary fence and push block. Install securely the auxiliary fence which is secured to the rip fence holder on the table. Feed the workpiece by hand until the end is about 25 mm from the front edge of the top table. Continue to feed using the push block on the top of the auxiliary fence until the cut is complete.

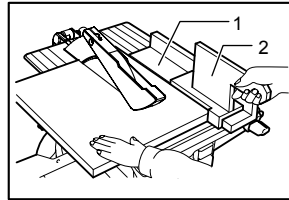

012216

1. Auxiliary fence
2. Push block

Carrying tool

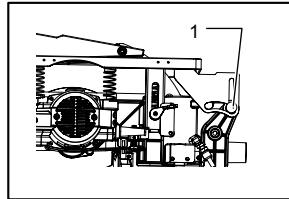

012217

1. Stopper pin

Make sure that the tool is unplugged. The table must be fixed at the top position. Secure the blade at 0° bevel angle and the turn base at left miter angle fully. Lower the handle fully and lock it in the lowered position by fully pushing in the stopper pin.

Carry the tool by holding both sides of the tool base as shown in the figure. If you remove the holders, dust bag, etc., you can carry the tool more easily.

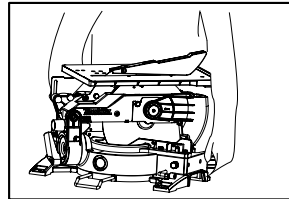

012218

⚠CAUTION:

- Always secure all moving portions before carrying the tool.

MAINTENANCE

⚠CAUTION:

- Always be sure that the tool is switched off and unplugged before attempting to perform inspection or maintenance.
- Never use gasoline, benzene, thinner, alcohol or the like. Discoloration, deformation or cracks may result.

⚠WARNING:

- Always be sure that the blade is sharp and clean for the best and safest performance.

Adjusting the cutting angle

This tool is carefully adjusted and aligned at the factory, but rough handling may have affected the alignment. If your tool is not aligned properly, perform the following:

1. Miter angle

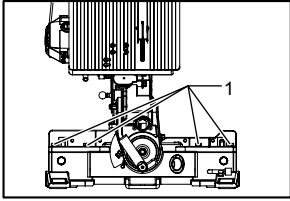

012219

1. Hex bolt

Loosen the grip which secures the turn base. Turn the turn base so that the pointer points to 0° on the miter scale. Tighten the grip and loosen the hex bolts securing the guide fence using the socket wrench.

Lower the handle fully and lock it in the lowered position by pushing in the stopper pin. Square the side of the blade with the face of the guide fence using a triangular rule, try-square, etc. Then securely tighten the hex bolts on the guide fence in the order from the right side.

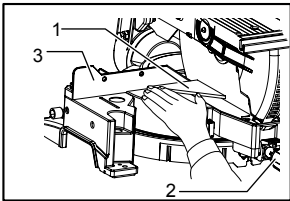

012220

1. Triangular rule
2. Grip
3. Guide fence

2. Bevel angle

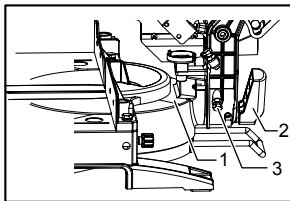

012221

(1) 0° bevel angle

Lower the handle fully and lock it in the lowered position by pushing in the stopper pin. Loosen the lever at the rear of the tool.

Turn the 0° bevel angle adjusting bolt on the right side of the turn base two or three revolutions clockwise to tilt the blade to the right.

Carefully square the side of the blade with the top surface of the turn base using the triangular rule, try-square, etc. by turning the 0° bevel angle adjusting bolt counterclockwise.

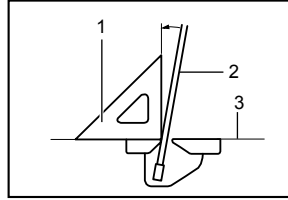

001819

1. Triangular rule
2. Saw blade
3. Top surface of turn table

Make sure that the pointer on the turn base point to 0° on the bevel scale on the arm. If it does not point to 0°, loosen the screw which secures the pointer and adjust the pointer so that it will point to 0°.

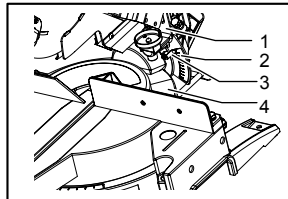

012222

(2) 45° bevel angle

1. Arm
2. Bevel scale
3. Pointer
4. Turn base

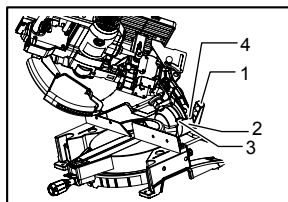

012223

1. Lever
2. Arm
3. Pointer
4. 45° bevel angle adjusting bolt

Adjust the 45° bevel angle only after performing 0° bevel angle adjustment. To adjust left 45° bevel angle, loosen the lever and tilt the blade to the left fully. Make sure that the pointer on the arm points to 45° on the bevel scale on the arm. If the pointer does not point to 45°, turn the 45° bevel angle adjusting bolt on the left side of the arm until the pointer points to 45°.

Replacing carbon brushes

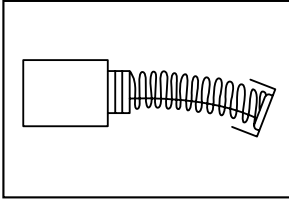

007834

Remove and check the carbon brushes regularly. Replace when they wear down to 3mm in length. Keep the carbon brushes clean and free to slip in the holders. Both carbon brushes should be replaced at the same time. Use only identical carbon brushes.

Use a screwdriver to remove the brush holder caps. Take out the worn carbon brushes, insert the new ones and secure the brush holder caps.

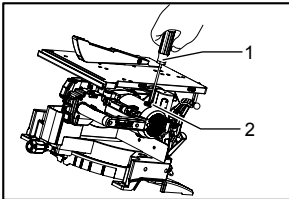

1. Screwdriver
2. Brush holder cap

012227

After use

- After use, wipe off chips and dust adhering to the tool with a cloth or the like. Keep the blade guards clean according to the directions in the previously covered section titled "Blade guard". Lubricate the sliding portions with machine oil to prevent rust.

To maintain product SAFETY and RELIABILITY, repairs, any other maintenance or adjustment should be performed by Makita Authorized Service Centers, always using Makita replacement parts.

OPTIONAL ACCESSORIES

CAUTION:

- These accessories or attachments are recommended for use with your Makita tool specified in this manual. The use of any other accessories or attachments might present a risk of injury to persons. Only use accessory or attachment for its stated purpose.

If you need any assistance for more details regarding these accessories, ask your local Makita Service Center.

- Steel & Carbide-tipped saw blades
- Vise assembly (Horizontal vise)
- Vertical vise

- Socket wrench 13
- Holder set
- Dust bag
- Triangular rule
- Blade cover
- Push stick
- Ruler assembly (Rip fence)

NOTE:

- Some items in the list may be included in the tool package as standard accessories. They may differ from country to country.

Makita Corporation