

INSTRUCTION MANUAL

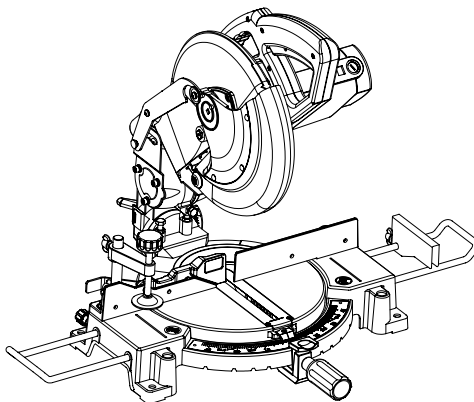

Compound Miter Saw

MLS100



015058

 DOUBLE INSULATION

IMPORTANT: Read Before Using.

ENGLISH (Original instructions)

SPECIFICATIONS

Model	MLS100
Blade diameter	255 mm
Blade body thickness	1.6 mm - 2.4 mm
Hole diameter	
For all countries other than European countries	25.4 mm
For European countries	30 mm
Max. Cutting capacities (H x W) with blade 255 mm in diameter	

Bevel angle	Miter angle	
	0°	45° (left and right)
0°	75 mm x 130 mm	75 mm x 90 mm
45° (left)	48 mm x 120 mm	48 mm x 90 mm

No load speed (min ⁻¹)	4,200
Dimensions (L x W x H)	610 mm x 485 mm x 515 mm
Net weight	14.7 kg
Safety class	II

- Due to our continuing program of research and development, the specifications herein are subject to change without notice.
- Note: Specifications may differ from country to country.
- Weight according to EPTA-Procedure 01/2003

END217-5

Symbols

The following show the symbols used for the equipment. Be sure that you understand their meaning before use.



- Read instruction manual.



- DOUBLE INSULATION



- To avoid injury from flying debris, keep holding the saw head down, after making cuts, until the blade has come to a complete stop.



- Do not place hand or fingers close to the blade.



- For your safety, remove the chips, small pieces, etc. from the table top before operation.



- Always set SUB-FENCE to left position when performing left bevel cuts. Failure to do so may cause serious injury to operator.



- To loosen the bolt, turn it clockwise.



- Only for EU countries
Do not dispose of electric equipment together with household waste material! In observance of the European Directive, on Waste Electric and Electronic Equipment and its implementation in accordance with national law, electric equipment that have reached the end of their life must

be collected separately and returned to an environmentally compatible recycling facility.

ENE004-1

Intended use

The tool is intended for accurate straight and miter cutting in wood. With appropriate saw blades, aluminum can also be sawed.

ENF002-2

Power supply

The tool should be connected only to a power supply of the same voltage as indicated on the nameplate, and can only be operated on single-phase AC supply. They are double-insulated and can, therefore, also be used from sockets without earth wire.

ENG905-1

Noise

The typical A-weighted noise level determined according to EN61029:

Sound pressure level (L_{pA}) : 92 dB (A)

Sound power level (L_{WA}) : 105 dB (A)

Uncertainty (K) : 3 dB (A)

Wear ear protection

ENH003-15

For European countries only

EC Declaration of Conformity

Makita declares that the following Machine(s):

Designation of Machine:

Compound Miter Saw

Model No./ Type: MLS100

Conforms to the following European Directives:
2006/42/EC

They are manufactured in accordance with the following standard or standardized documents:

EN61029

The technical file in accordance with 2006/42/EC is available from:

Makita, Jan-Baptist Vinkstraat 2, 3070, Belgium

30.5.2014



000331

Yasushi Fukaya
Director

Makita, Jan-Baptist Vinkstraat 2, 3070, Belgium

GEA005-3

General Power Tool Safety Warnings

⚠ WARNING Read all safety warnings and all instructions. Failure to follow the warnings and instructions may result in electric shock, fire and/or serious injury.

Save all warnings and instructions for future reference.

The term "power tool" in the warnings refers to your mains-operated (corded) power tool or battery-operated (cordless) power tool.

Work area safety

1. **Keep work area clean and well lit.** Cluttered or dark areas invite accidents.
2. **Do not operate power tools in explosive atmospheres, such as in the presence of flammable liquids, gases or dust.** Power tools create sparks which may ignite the dust or fumes.
3. **Keep children and bystanders away while operating a power tool.** Distractions can cause you to lose control.

Electrical safety

4. **Power tool plugs must match the outlet. Never modify the plug in any way. Do not use any adapter plugs with earthed (grounded) power tools.** Unmodified plugs and matching outlets will reduce risk of electric shock.
5. **Avoid body contact with earthed or grounded surfaces such as pipes, radiators, ranges and refrigerators.** There is an increased risk of electric shock if your body is earthed or grounded.
6. **Do not expose power tools to rain or wet conditions.** Water entering a power tool will increase the risk of electric shock.

7. **Do not abuse the cord. Never use the cord for carrying, pulling or unplugging the power tool. Keep cord away from heat, oil, sharp edges or moving parts.** Damaged or entangled cords increase the risk of electric shock.
8. **When operating a power tool outdoors, use an extension cord suitable for outdoor use.** Use of a cord suitable for outdoor use reduces the risk of electric shock.
9. **If operating a power tool in a damp location is unavoidable, use a residual current device (RCD) protected supply.** Use of an RCD reduces the risk of electric shock.
10. **Use of power supply via a RCD with a rated residual current of 30mA or less is always recommended.**

Personal safety

11. **Stay alert, watch what you are doing and use common sense when operating a power tool. Do not use a power tool while you are tired or under the influence of drugs, alcohol or medication.** A moment of inattention while operating power tools may result in serious personal injury.
12. **Use personal protective equipment. Always wear eye protection.** Protective equipment such as dust mask, non-skid safety shoes, hard hat, or hearing protection used for appropriate conditions will reduce personal injuries.
13. **Prevent unintentional starting. Ensure the switch is in the off-position before connecting to power source and/or battery pack, picking up or carrying the tool.** Carrying power tools with your finger on the switch or energising power tools that have the switch on invites accidents.
14. **Remove any adjusting key or wrench before turning the power tool on.** A wrench or a key left attached to a rotating part of the power tool may result in personal injury.
15. **Do not overreach. Keep proper footing and balance at all times.** This enables better control of the power tool in unexpected situations.
16. **Dress properly. Do not wear loose clothing or jewellery. Keep your hair, clothing, and gloves away from moving parts.** Loose clothes, jewellery or long hair can be caught in moving parts.
17. **If devices are provided for the connection of dust extraction and collection facilities, ensure these are connected and properly used.** Use of dust collection can reduce dust-related hazards.

Power tool use and care

18. **Do not force the power tool. Use the correct power tool for your application.** The correct power tool will do the job better and safer at the rate for which it was designed.

19. **Do not use the power tool if the switch does not turn it on and off.** Any power tool that cannot be controlled with the switch is dangerous and must be repaired.
20. **Disconnect the plug from the power source and/or the battery pack from the power tool before making any adjustments, changing accessories, or storing power tools.** Such preventive safety measures reduce the risk of starting the power tool accidentally.
21. **Store idle power tools out of the reach of children and do not allow persons unfamiliar with the power tool or these instructions to operate the power tool.** Power tools are dangerous in the hands of untrained users.
22. **Maintain power tools. Check for misalignment or binding of moving parts, breakage of parts and any other condition that may affect the power tool's operation. If damaged, have the power tool repaired before use.** Many accidents are caused by poorly maintained power tools.
23. **Keep cutting tools sharp and clean.** Properly maintained cutting tools with sharp cutting edges are less likely to bind and are easier to control.
24. **Use the power tool, accessories and tool bits etc. in accordance with these instructions, taking into account the working conditions and the work to be performed.** Use of the power tool for operations different from those intended could result in a hazardous situation.

Service

25. **Have your power tool serviced by a qualified repair person using only identical replacement parts.** This will ensure that the safety of the power tool is maintained.
26. **Follow instruction for lubricating and changing accessories.**
27. **Keep handles dry, clean and free from oil and grease.**

ENB034-8

MITER SAW SAFETY WARNINGS

1. **Keep hands out of path of saw blade. Avoid contact with any coasting blade. It can still cause severe injury.**
2. **Check the saw blade carefully for cracks or deformation before operation. Replace damaged blades immediately.**
3. **Replace the kerf board when worn.**
4. **Use only saw blades specified by the manufacturer which conform to EN847-1.**
5. **Do not use saw blades manufactured from high speed steel.**
6. **Wear eye protection.**
7. **Wear hearing protection to reduce the risk of hearing loss.**
8. **Wear gloves for handling saw blade (saw blades shall be carried in a holder wherever practicable) and rough material.**
9. **Connect miter saws to a dust collecting device when sawing.**
10. **Select saw blades in relation to the material to be cut.**
11. **Do not use the saw to cut other than wood, aluminum or similar materials.**
12. **Always secure all moving portions before carrying the tool. When lifting or carrying the tool, do not use the guard as a carrying handle.**
13. **Do not operate saw without guards in place. Check blade guard for proper closing before each use. Do not operate saw if blade guard does not move freely and close instantly. Never clamp or tie the blade guard into the open position.**
14. **Keep the floor area free of loose material e.g. chips and cut-offs.**
15. **Use only saw blades that are marked with a maximum speed equal to or higher than the no load speed marked on the tool.**
16. **When the tool is fitted with a laser or LED, do not replace the laser or LED with a different type. Ask an authorized service center for repair.**
17. **Never remove any cut-offs or other parts of the workpiece from the cutting area whilst the tool is running with an unguarded saw blade.**
18. **Do not perform any operation freehand.** The workpiece must be secured firmly against the turn base and guide fence with the vise during all operations. Never use your hand to secure the workpiece.
19. **Ensure that the tool is stable before each cut.**
20. **Fix the tool to a work bench, if needed.**
21. **Support long workpieces with appropriate additional supports.**
22. **Never cut so small workpiece which cannot be securely held by the vise.** Improperly held workpiece may cause kickback and serious personal injury.
23. **Never reach around saw blade.**
24. **Turn off tool and wait for saw blade to stop before moving workpiece or changing settings.**
25. **Unplug tool before changing blade or servicing.**
26. **Stopper pin which locks the cutter head down is for carrying and storage purposes only and not for any cutting operations.**
27. **Do not use the tool in the presence of flammable liquids or gases.** The electrical operation of the tool could create an explosion and fire when exposed to flammable liquids or gases.

28. Use only flanges specified for this tool.
29. Be careful not to damage the arbor, flanges (especially the installing surface) or bolt. Damage to these parts could result in blade breakage.
30. Make sure that the turn base is properly secured so it will not move during operation.
31. For your safety, remove the chips, small pieces, etc. from the table top before operation.
32. Avoid cutting nails. Inspect for and remove all nails from the workpiece before operation.
33. Make sure the shaft lock is released before the switch is turned on.
34. Be sure that the blade does not contact the turn base in the lowest position.
35. Hold the handle firmly. Be aware that the saw moves up or down slightly during start-up and stopping.
36. Make sure the blade is not contacting the workpiece before the switch is turned on.
37. Before using the tool on an actual workpiece, let it run for a while. Watch for vibration or wobbling that could indicate poor installation or a poorly balanced blade.
38. Wait until the blade attains full speed before cutting.
39. Stop operation immediately if you notice anything abnormal.
40. Do not attempt to lock the trigger in the on position.
41. Be alert at all times, especially during repetitive, monotonous operations. Do not be lulled into a false sense of security. Blades are extremely unforgiving.
42. Always use accessories recommended in this manual. Use of improper accessories such as abrasive wheels may cause an injury.
43. Take care when slotting.
44. Some dust created from operation contains chemicals known to cause cancer, birth defects or other reproductive harm. Some examples of these chemicals are:
 - lead from lead-based-painted material and,
 - arsenic and chromium from chemically-treated lumber.
 Your risk from these exposures varies, depending on how often you do this type of work. To reduce your exposure to these chemicals: work in a well ventilated area and work with approved safety equipment, such as those dust masks that are specially designed to filter out microscopic particles.
45. To reduce the emitted noise, always be sure that the blade is sharp and clean.

46. The operator is adequately trained in the use, adjustment and operation of the machine.

SAVE THESE INSTRUCTIONS.

⚠WARNING:

DO NOT let comfort or familiarity with product (gained from repeated use) replace strict adherence to safety rules for the subject product. MISUSE or failure to follow the safety rules stated in this instruction manual may cause serious personal injury.

INSTALLATION

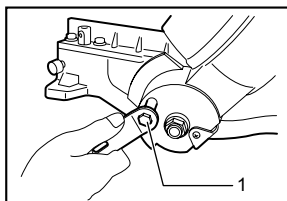

1. Wrench

007766

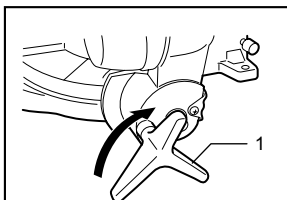

1. Knob

007772

When the tool is shipped, the handle is locked in the lowered position by the stopper pin. Loosen the bolt with a wrench provided with the tool and move the saw head to the right angle. Remove the bolt and secure the saw head with the knob.

Installing auxiliary plate

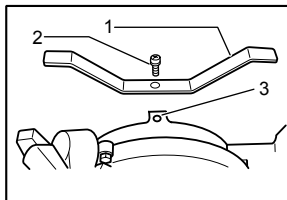

1. Auxiliary plate
2. Screw
3. Base

007830

Installing the auxiliary plate using the hole in the tool's base and secure it by tightening the screw.

Bench mounting

When the tool is shipped, the handle is locked in the lowered position by the stopper pin. Release the stopper pin by lowering the handle slightly and pulling the stopper pin.

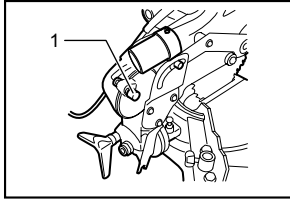

1. Stopper pin

007754

This tool should be bolted with four bolts to a level and stable surface using the bolt holes provided in the tool's base. This will help prevent tipping and possible injury.

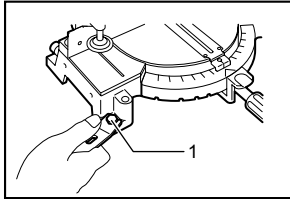

1. Bolt

007767

FUNCTIONAL DESCRIPTION

⚠CAUTION:

- Always be sure that the tool is switched off and unplugged before adjusting or checking function on the tool.

Blade guard

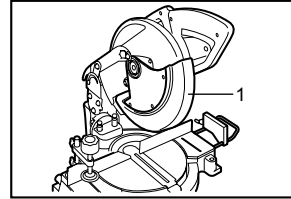

1. Blade guard

007755

When lowering the handle, the blade guard rises automatically. The guard is spring loaded so it returns to its original position when the cut is completed and the handle is raised. NEVER DEFEAT OR REMOVE THE BLADE GUARD OR THE SPRING WHICH ATTACHES TO THE GUARD.

In the interest of your personal safety, always maintain the blade guard in good condition. Any irregular operation of the blade guard should be corrected immediately. Check to assure spring loaded return action of guard. NEVER USE THE TOOL IF THE BLADE GUARD OR SPRING ARE DAMAGED, FAULTY OR REMOVED. DOING SO IS HIGHLY DANGEROUS AND CAN CAUSE SERIOUS PERSONAL INJURY.

If the see-through blade guard becomes dirty, or sawdust adheres to it in such a way that the blade is no longer easily visible, unplug the saw and clean the guard carefully with a damp cloth. Do not use solvents or any petroleum-based cleaners on the plastic guard.

If the see-through blade guard becomes dirty, or sawdust adheres to it in such a way that the blade and/or workpiece is no longer easily visible, unplug the saw and clean the guard carefully with a damp cloth. Do not use solvents or any petroleum-based cleaners on the plastic guard.

If the blade guard is especially dirty and vision through the guard is impaired, use the supplied wrench to loosen the hex bolt holding the center cover. Loosen the hex bolt by turning it counterclockwise and raise the blade guard and center cover. With the blade guard so positioned, cleaning can be more completely and efficiently accomplished. When cleaning is complete, reverse procedure above and secure bolt. Do not remove spring holding blade guard. If guard becomes discolored through age or UV light exposure, contact a Makita service center for a new guard. DO NOT DEFEAT OR REMOVE GUARD.

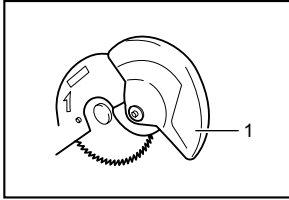

1. Blade guard

001782

Kerf board

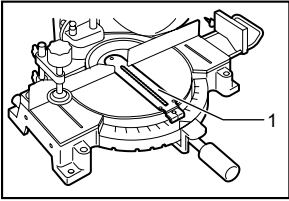

1. Kerf board

007777

This tool is provided with the kerf board in the turn base to minimize tearing on the exit side of a cut. If the kerf groove has not yet been cut in the kerf board by the factory, you should cut the groove before actually using the tool to cut a workpiece. Switch on the tool and lower the blade gently to cut a groove in the kerf board.

Maintaining maximum cutting capacity

This tool is factory adjusted to provide the maximum cutting capacity for a 255 mm saw blade.

When installing a new blade, always check the lower limit position of the blade and if necessary, adjust it as follows:

First, unplug the tool. Lower the handle completely. Use the wrench to turn the adjusting bolt until the periphery of the blade extends slightly below the top surface of the turn base at the point where the front face of the guide fence meets the top surface of the turn base.

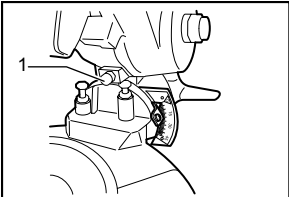

1. Adjusting bolt

007832

With the tool unplugged, rotate the blade by hand while holding the handle all the way down to be sure that the blade does not contact any part of the lower base. Re-adjust slightly, if necessary.

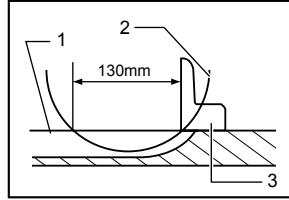

1. Top surface of turn base
2. Periphery of blade
3. Guide fence

007831

⚠CAUTION:

- After installing a new blade, always be sure that the blade does not contact any part of the lower base when the handle is lowered completely. Always do this with the tool unplugged.

Adjusting the miter angle

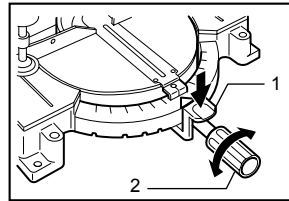

1. Lock lever
2. Grip

007768

Loosen the grip by turning counterclockwise. Turn the turn base while pressing down the lock lever. When you have moved the grip to the position where the pointer points to the desired angle on the miter scale, securely tighten the grip clockwise.

⚠CAUTION:

- When turning the turn base, be sure to raise the handle fully.
- After changing the miter angle, always secure the turn base by tightening the grip firmly.

Adjusting the bevel angle

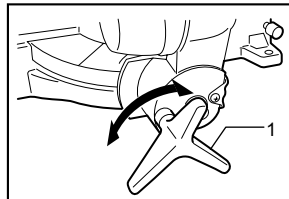

1. Knob

007763

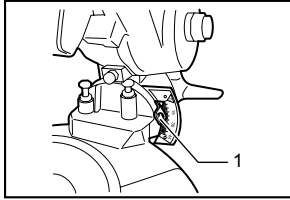

1. Pointer

007757

To adjust the bevel angle, loosen the knob at the rear of the tool counterclockwise.

Push the handle to the left to tilt the saw blade until the pointer points to the desired angle on the bevel scale. Then tighten the knob clockwise firmly to secure the arm.

⚠CAUTION:

- When tilting the saw blade, be sure to raise the handle fully.
- After changing the bevel angle, always secure the arm by tightening the knob clockwise.

Switch action

⚠CAUTION:

- Before plugging in the tool, always check to see that the switch trigger actuates properly and returns to the "OFF" position when released.

For European countries

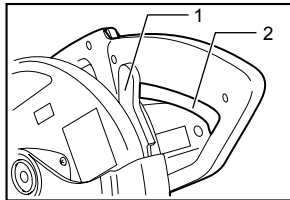

1. Lever
2. Switch trigger

007900

To start the tool, push the lever to the right and then pull the switch trigger. Release the switch trigger to stop.

For all countries other than European countries

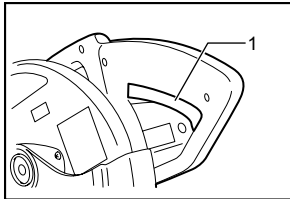

1. Switch trigger

007761

To start the tool, simply pull the switch trigger. Release the switch trigger to stop.

⚠WARNING:

- NEVER use tool without a fully operative switch trigger. Any tool with an inoperative switch is HIGHLY DANGEROUS and must be repaired before further usage.

ASSEMBLY

⚠CAUTION:

- Always be sure that the tool is switched off and unplugged before carrying out any work on the tool.

Installing or removing saw blade

⚠CAUTION:

- Always be sure that the tool is switched off and unplugged before installing or removing the blade.
- Use only the Makita wrench provided to install or remove the blade. Failure to do so may result in overtightening or insufficient tightening of the hex bolt. This could cause an injury.

When removing or installing the blade, keep the handle in the raised position.

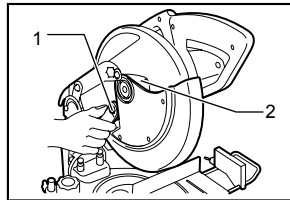

1. Wrench
2. Center cover

007771

To remove the blade, use the wrench to loosen the hex bolt holding the center cover by turning it counterclockwise. Raise the blade guard and center cover.

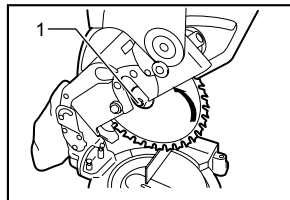

1. Hex bolt

007774

Press the shaft lock to lock the spindle and use the wrench to loosen the hex bolt clockwise. Then remove the hex bolt, outer flange and blade.

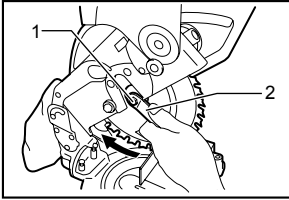

1. Hex bolt
2. Wrench

007770

To install the blade, mount it carefully onto the spindle, making sure that the direction of the arrow on the surface of the blade matches the direction of the arrow on the blade case. Install the outer flange and hex bolt, and then use the wrench to tighten the hex bolt (left-handed) securely counterclockwise while pressing the shaft lock.

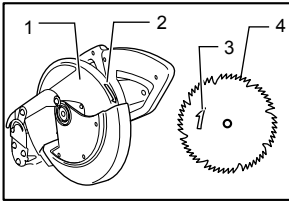

1. Blade case
2. Arrow
3. Arrow
4. Saw blade

007808

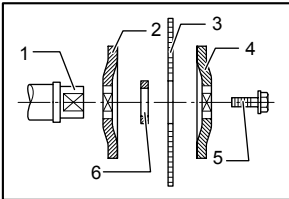

1. Spindle
2. Flange
3. Saw blade
4. Flange
5. Hex bolt
6. Ring

004852

⚠ CAUTION:

- The ring 25.4 mm or 30 mm in outer diameter is factory-installed onto the spindle. Before mounting the blade onto the spindle, always be sure that the correct ring for the arbor hole of the blade you intend to use is installed onto the spindle.

Install the outer flange and hex bolt, and then use the wrench to tighten the hex bolt (left-handed) securely counterclockwise while pressing the shaft lock.

Return the blade guard and center cover to its original position. Then tighten the hex bolt clockwise to secure the center cover. Lower the handle to make sure that the blade guard moves properly. Make sure shaft lock has released spindle before making cut.

Sub-fence (for European countries only)

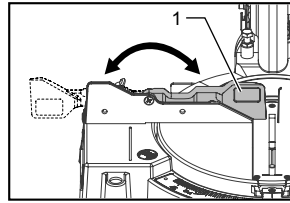

1. Sub-fence

015064

This tool is equipped with the sub-fence. Usually position the sub-fence inside. However, when performing left bevel cuts, flip it outward.

⚠ CAUTION:

- When performing left bevel cuts, flip the sub-fence outward. Otherwise, it will contact the blade or a part of the tool, causing possible serious injury to the operator.

Dust bag

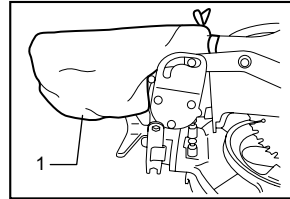

1. Dust bag

007775

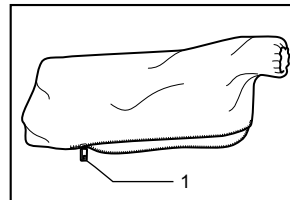

1. Fastener

007776

The use of the dust bag makes cutting operations clean and dust collection easy. To attach the dust bag, fit it onto the dust nozzle.

When the dust bag is about half full, remove the dust bag from the tool and pull the fastener out. Empty the dust bag of its contents, tapping it lightly so as to remove particles adhering to the insides which might hamper further collection.

NOTE:

If you connect a Makita vacuum cleaner to your saw, more efficient and cleaner operations can be performed.

Securing workpiece

⚠WARNING:

- It is extremely important to always secure the workpiece properly and tightly with the vise. Failure to do so can cause the tool to be damaged and/or the workpiece to be destroyed. **PERSONAL INJURY MAY ALSO RESULT.** Also, after a cutting operation, **DO NOT** raise the blade until the blade has come to a complete stop.

⚠CAUTION:

- When cutting long workpieces, use supports that are as high as the top surface level of the turn base. Do not rely solely on the vertical vise and/or horizontal vise to secure the workpiece. Thin material tends to sag. Support workpiece over its entire length to avoid blade pinch and possible **KICKBACK.**

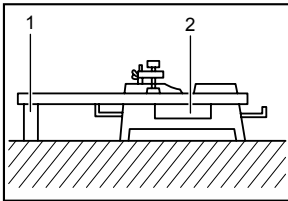

001549

- Support
- Turn base

Vertical vise

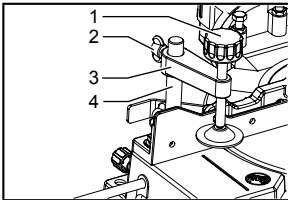

015059

- Vise knob
- Screw
- Vise arm
- Vise rod

The vertical vise can be installed in two positions on either the left or right side of the guide fence. Insert the vise rod into the hole in the guide fence and tighten the screw to secure the vise rod.

Position the vise arm according to the thickness and shape of the workpiece and secure the vise arm by tightening the screw. Make sure that no part of the tool contacts the vise when lowering the handle all the way. If some part contacts the vise, re-position the vise.

Press the workpiece flat against the guide fence and the turn base. Position the workpiece at the desired cutting position and secure it firmly by tightening the vise knob.

⚠CAUTION:

- The workpiece must be secured firmly against the turn base and guide fence with the vise during all operations.

OPERATION

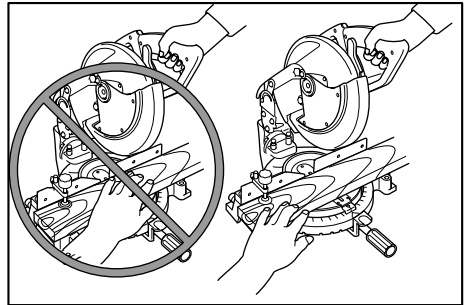

010852

⚠CAUTION:

- Before use, be sure to release the handle from the lowered position by pulling the stopper pin.
- Make sure the blade is not contacting the workpiece, etc. before the switch is turned on.
- Do not apply excessive pressure on the handle when cutting. Too much force may result in overload of the motor and/or decreased cutting efficiency. Push down handle with only as much force as is necessary for smooth cutting and without significant decrease in blade speed.
- Gently press down the handle to perform the cut. If the handle is pressed down with force or if lateral force is applied, the blade will vibrate and leave a mark (saw mark) in the workpiece and the precision of the cut will be impaired.

1. Press cutting

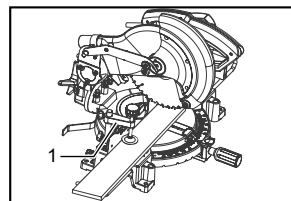

015060

- Vertical vise

Secure the workpiece with the vise. Switch on the tool without the blade making any contact and wait until the blade attains full speed before lowering. Then gently lower the handle to the fully lowered position to cut the workpiece. When the cut is completed, switch off the tool and **WAIT UNTIL THE BLADE HAS COME TO A COMPLETE STOP** before returning the blade to its fully elevated position.

2. Miter cutting

Refer to the previously covered "Adjusting the miter angle".

3. Bevel cut

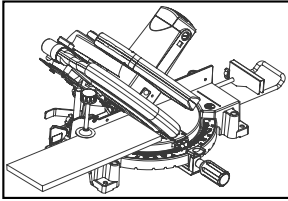

015061

Loosen the knob and tilt the saw blade to set the bevel angle (Refer to the previously covered "Adjusting the bevel angle"). Be sure to retighten the knob firmly to secure the selected bevel angle safely. Secure the workpiece with a vise. Switch on the tool without the blade making any contact and wait until the blade attains full speed. Then gently lower the handle to the fully lowered position while applying pressure in parallel with the blade. When the cut is completed, switch off the tool and WAIT UNTIL THE BLADE HAS COME TO A COMPLETE STOP before returning the blade to its fully elevated position.

⚠ CAUTION:

- Always be sure that the blade will move down to bevel direction during a bevel cut. Keep hands out of path of saw blade.
- During a bevel cut, it may create a condition whereby the piece cut off will come to rest against the side of the blade. If the blade is raised while the blade is still rotating, this piece may be caught by the blade, causing fragments to be scattered which is dangerous. The blade should be raised ONLY after the blade has come to a complete stop.
- When pressing the handle down, apply pressure parallel to the blade. If the pressure is not parallel to the blade during a cut, the angle of the blade might be shifted and the precision of the cut will be impaired.
- (Only for European countries) always set the sub-fence outside when performing left bevel cuts.

4. Compound cutting

Compound cutting is the process in which a bevel angle is made at the same time in which a miter angle is being cut on a workpiece. Compound cutting can be performed at angle shown in the table.

Bevel angle	Miter angle
45°	Left and Right 0° - 45°

006366

When performing compound cutting, refer to "Press cutting", "Miter cutting" and "Bevel cut" explanations.

5. Cutting aluminum extrusion

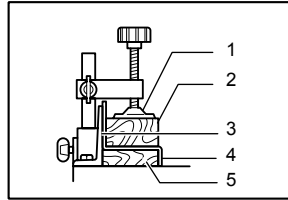

001844

1. Vise
2. Spacer block
3. Guide fence
4. Aluminum extrusion
5. Spacer block

When securing aluminum extrusions, use spacer blocks or pieces of scrap as shown in the figure to prevent deformation of the aluminum. Use a cutting lubricant when cutting the aluminum extrusion to prevent build-up of the aluminum material on the blade.

⚠ CAUTION:

- Never attempt to cut thick or round aluminum extrusions. Thick aluminum extrusions may come loose during operation and round aluminum extrusions cannot be secured firmly with this tool.

6. Wood facing

Use of wood facing helps to assure splinter-free cuts in workpieces. Attach a wood facing to the guide fence using the holes in the guide fence. See the figure concerning the dimensions for a suggested wood facing.

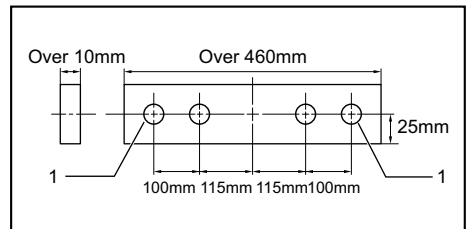

1. Hole

007833

⚠ CAUTION:

- Use straight wood of even thickness as the wood facing.
- Use screws to attach the wood facing to the guide fence. The screws should be installed so that the screw heads are below the surface of the wood facing.
- When the wood facing is attached, do not turn the turn base with the handle lowered. The blade and/or the wood facing will be damaged.
- The maximum cutting width will be smaller by the width of wood facing.

7. Cutting repetitive lengths

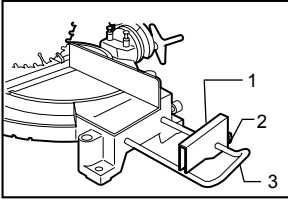

007760

1. Set plate
2. Screw
3. Holder

When cutting several pieces of stock to the same length, ranging from 240 mm to 380 mm, use of the set plate (optional accessory) will facilitate more efficient operation. Install the set plate on the holder (optional accessory) as shown in the figure. Align the cutting line on your workpiece with either the left or right side of the groove in the kerf board, and while holding the workpiece from moving, move the set plate flush against the end of the workpiece. Then secure the set plate with the screw. When the set plate is not used, loosen the screw and turn the set plate out of the way.

Carrying tool

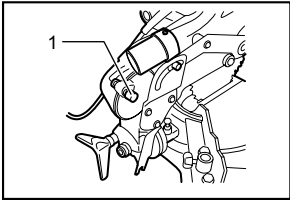

007754

1. Stopper pin

Make sure that the tool is unplugged. Secure the blade at 0° bevel angle and the turn base at left miter angle fully. Lower the handle fully and lock it in the lowered position by pushing in the stopper pin.

Carry the tool by carrying grip as shown in the figure. If you remove the holders, dust bag, etc., you can carry the tool more easily.

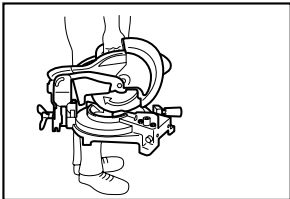

007759

⚠CAUTION:

- Always secure all moving portions before carrying the tool.
- Stopper pin is for carrying and storage purposes only and not for any cutting operations.

MAINTENANCE

⚠CAUTION:

- Always be sure that the tool is switched off and unplugged before attempting to perform inspection or maintenance.
- Never use gasoline, benzine, thinner, alcohol or the like. Discoloration, deformation or cracks may result.

⚠WARNING:

- Always be sure that the blade is sharp and clean for the best and safest performance.

Adjusting the cutting angle

This tool is carefully adjusted and aligned at the factory, but rough handling may have affected the alignment. If your tool is not aligned properly, perform the following:

1. Miter angle

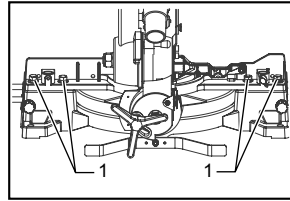

015062

1. Hex bolt

Loosen the grip which secures the turn base. Turn the turn base so that the pointer points to 0° on the miter scale. Tighten the grip and loosen the hex bolts securing the guide fence using the wrench. If the pointer does not point to 0° on the miter scale, loosen the screw which secures the pointer and move and secure the pointer plate so that the pointer points to 0° on the miter scale.

Lower the handle fully and lock it in the lowered position by pushing in the stopper pin. Square the side of the blade with the face of the guide fence using a triangular rule, try-square, etc. Then securely tighten the hex bolts on the guide fence in the order from the right side.

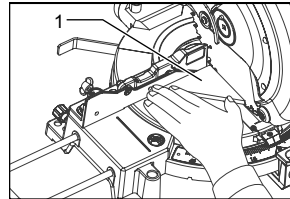

015063

1. Triangular rule

2. Bevel angle

(1) 0° bevel angle

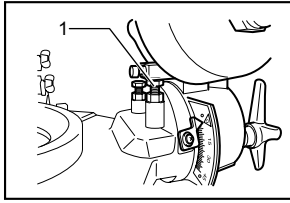

007752

Lower the handle fully and lock it in the lowered position by pushing in the stopper pin. Loosen the knob at the rear of the tool. Loosen the hex nut and turn the 0° bevel angle adjusting bolt on the right side of the turn base two or three revolutions clockwise to tilt the blade to the right.

Carefully square the side of the blade with the top surface of the turn base using the triangular rule, try-square, etc. by turning the 0° bevel angle adjusting bolt counterclockwise. Then tighten the hex nut to secure the 0° bevel angle adjusting bolt and tighten the knob securely.

Make sure that the pointer on the arm points to 0° on the bevel scale. If it does not point to 0° on the bevel scale, loosen the screw which secures the pointer and move and secure the pointer plate so that the pointer points to 0° on the bevel scale.

1. 0° adjusting bolt

(2) 45° bevel angle

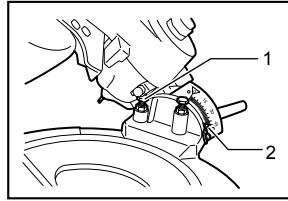

007751

1. 45° bevel angle adjusting bolt
2. Pointer

Adjust the 45° bevel angle only after performing 0° bevel angle adjustment. To adjust left 45° bevel angle, loosen the knob and tilt the blade to the left fully. Make sure that the pointer on the arm points to 45° on the bevel scale on the arm. If the pointer does not point to 45°, turn the 45° bevel angle adjusting bolt on the left side of the arm until the pointer points to 45°.

Replacing carbon brushes

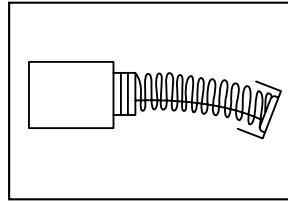

007834

Remove and check the carbon brushes regularly. Replace when they wear down to 3 mm in length. Keep the carbon brushes clean and free to slip in the holders. Both carbon brushes should be replaced at the same time. Use only identical carbon brushes.

Use a screwdriver to remove the brush holder caps. Take out the worn carbon brushes, insert the new ones and secure the brush holder caps.

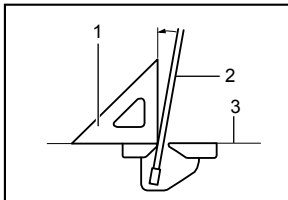

010798

1. Triangular rule
2. Saw blade
3. Top surface of turn base

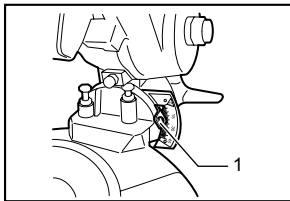

007757

1. Pointer

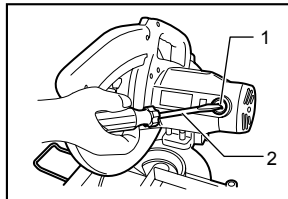

007756

1. Brush holder cap
2. Screwdriver

After use

- After use, wipe off chips and dust adhering to the tool with a cloth or the like. Keep the blade guard clean according to the directions in the previously covered section titled "Blade guard". Lubricate the sliding portions with machine oil to prevent rust.

To maintain product SAFETY and RELIABILITY, repairs, any other maintenance or adjustment should be performed by Makita Authorized Service Centers, always using Makita replacement parts.

Makita Jan-Baptist Vinkstraat 2, 3070, Belgium
Makita Corporation Anjo, Aichi, Japan